



## **GS Load Center**



**GRIDHybrid™**

DESIGNED FOR  
**FLEXgrid™**  
OPERATION

## **Installation Manual**



## About OutBack Power Technologies

OutBack Power Technologies is a leader in advanced energy conversion technology. OutBack products include true sine wave inverter/chargers, maximum power point tracking charge controllers, and system communication components, as well as circuit breakers, batteries, accessories, and assembled systems.

## Grid/Hybrid™

As a leader in off-grid energy systems designed around energy storage, OutBack Power is an innovator in Grid/Hybrid system technology, providing the best of both worlds: grid-tied system savings during normal or daylight operation, and off-grid independence during peak energy times or in the event of a power outage or an emergency. Grid/Hybrid systems have the intelligence, agility and interoperability to operate in multiple energy modes quickly, efficiently, and seamlessly, in order to deliver clean, continuous and reliable power to residential and commercial users while maintaining grid stability.

## Designed for FLEXgrid™ Operation

Selected OutBack Power products are designated as designed for FLEXgrid operation for their ability to support the design and operation of a Grid/Hybrid system. FLEXgrid products perform or manage functions including system communication, control, programming, charging, energy storage, and power conversion.

Only OutBack Power makes Grid/Hybrid systems and FLEXgrid products.

## Contact Information

Address:	Corporate Headquarters 5917 – 195 <sup>th</sup> Street N.E. Arlington, WA 98223 USA	European Office Hansastrasse 8 D-91126 Schwabach, Germany
Telephone:	+1.360.435.6030 +1.360.618.4363 (Technical Support) +1.360.435.6019 (Fax)	+49.9122.79889.0 +49.9122.79889.21 (Fax)
Email:	Support@outbackpower.com	
Website:	<a href="http://www.outbackpower.com">http://www.outbackpower.com</a>	

## Disclaimer

UNLESS SPECIFICALLY AGREED TO IN WRITING, OUTBACK POWER TECHNOLOGIES:

(a) MAKES NO WARRANTY AS TO THE ACCURACY, SUFFICIENCY OR SUITABILITY OF ANY TECHNICAL OR OTHER INFORMATION PROVIDED IN ITS MANUALS OR OTHER DOCUMENTATION.

(b) ASSUMES NO RESPONSIBILITY OR LIABILITY FOR LOSS OR DAMAGE, WHETHER DIRECT, INDIRECT, CONSEQUENTIAL OR INCIDENTAL, WHICH MIGHT ARISE OUT OF THE USE OF SUCH INFORMATION. THE USE OF ANY SUCH INFORMATION WILL BE ENTIRELY AT THE USER'S RISK.

OutBack Power Technologies cannot be responsible for system failure, damages, or injury resulting from improper installation of their products.

## Notice of Copyright

*GS Load Center Installation Manual* © 2012 by OutBack Power Technologies. All Rights Reserved.

## Trademarks

OutBack Power, the OutBack Power logo, FLEXpower ONE, Grid/Hybrid, and FLEXgrid are trademarks owned and used by OutBack Power Technologies, Inc. The ALPHA logo and the phrase "member of the Alpha Group" are trademarks owned and used by Alpha Technologies Inc. These trademarks may be registered in the United States and other countries.

## Date and Revision

October 2012, Revision B

## Part Number

900-0123-01-00 Rev B



# Table of Contents

- Introduction ..... 3**
  - Welcome to OutBack Power Technologies.....3
  - GSLC – Components .....4
  - GSLC175-120/240 – Components .....5
  - GSLC175-230 – Components .....6
  - GSLC175-PV-120/240 – Components .....7
  - GSLC175-PV-230 – Components .....8
- Planning..... 9**
  - Tools Required.....9
  - Materials Required .....9
  - Location/Environmental Requirements.....9
- Installation ..... 11**
  - Hardware Options ..... 11
  - Remove Top Cover..... 12
  - Remove Front Door ..... 12
  - Remove Interior Cover..... 13
  - Installing the Internal Hardware ..... 13
    - Assembling DC Positive Cable Plate.....14
    - Installing Inverter Positive Bus Bars .....15
    - Installing Inverter Main Disconnects.....16
    - Installing DC Shunts.....17
    - Installing PV and AC Circuit Breakers and GFDI .....18
    - Mounting FLEXmax Charge Controller.....21
    - Mounting the HUB Communications Manager .....22
  - Wiring ..... 23
    - Grounding .....23
    - DC Wiring.....25
    - AC Wiring.....29
    - Wiring Diagrams.....37
- Specifications ..... 41**
  - Electrical Specifications..... 41
  - Mechanical Specifications..... 41
  - Regulatory Specifications..... 41
  - Definitions..... 42
- Index..... 43**

## List of Tables

- Table 1 Bus Bar and Circuit Breaker Size and Torque Requirements ..... 13
- Table 2 Terminal Bus Bar (TBB) Wire Size and Torque Requirements ..... 23
- Table 3 Electrical Specifications..... 41
- Table 4 Mechanical Specifications..... 41
- Table 5 Terms and Definitions..... 42

## List of Figures

Figure 1	GS Load Center (GSLC) .....	3
Figure 2	GSLC Components .....	4
Figure 3	GSLC175-120/240 Components .....	5
Figure 4	GSLC175-230 Components.....	6
Figure 5	GSLC175-PV-120/240 Components.....	7
Figure 6	GSLC175-PV-230 Components.....	8
Figure 7	Dimensions .....	9
Figure 8	Knockouts and Mounting Holes for FLEXmax and HUB.....	10
Figure 9	GSLC – Additional Components .....	11
Figure 10	GSLC175-120/240 and GSLC175-230 – Additional Components .....	11
Figure 11	Removing the Top Cover from the GSLC.....	12
Figure 12	Removing the Front Door from the GSLC .....	12
Figure 13	Removing the Interior Cover from the GSLC.....	13
Figure 14	DC Positive Cable Plate .....	13
Figure 15	Assembling the DC Positive Cable Plate .....	14
Figure 16	Inverter Bus Bars .....	15
Figure 17	Inverter Main Disconnects .....	16
Figure 18	DC Shunts.....	17
Figure 19	Circuit Breakers .....	18
Figure 20	Mounting the GSLC .....	19
Figure 20	Mounting the GSLC (continued).....	20
Figure 21	Mounting the Charge Controller to the GSLC Enclosure .....	21
Figure 22	Mounting the HUB to the GSLC Enclosure.....	22
Figure 23	Grounding.....	23
Figure 24	Removing Bonding Connections.....	24
Figure 25	Battery Connections.....	25
Figure 26	FNDC and Wiring Block .....	26
Figure 27	Installing the FNDC .....	26
Figure 28	PV Connections in the GSLC.....	28
Figure 29	PV Connections in the FLEXmax Charge Controller .....	28
Figure 30	AC Terminal Bus Bars (split-phase).....	29
Figure 31	Inverter AC Connections (split-phase).....	30
Figure 32	AC Terminal Bus Bars (single-phase) .....	31
Figure 33	Inverter AC Connections (single-phase) .....	32
Figure 34	Maintenance Bypass Wiring (split-phase) .....	33
Figure 35	Maintenance Bypass Wiring (single-phase).....	34
Figure 36	Bypass Switches.....	35
Figure 37	OutBack Bypass (split-phase) .....	35
Figure 38	Bypass Switching for Multiple Inverters (split-phase).....	36
Figure 39	Wiring Diagram – GSLC175-120/240.....	37
Figure 40	Wiring Diagram – GSLC175-PV-120/240 with FNDC .....	38
Figure 41	Wiring Diagram – GSLC175-230.....	39
Figure 42	Wiring Diagram – GSLC175-PV-230 with FNDC .....	40



# Introduction

## Welcome to OutBack Power Technologies

Thank you for purchasing a GS Load Center (GSLC) from OutBack Power Technologies. The GSLC is part of an OutBack Grid/Hybrid™ system. It is a balance-of-systems enclosure intended to work with Radian Series (GS) inverter/chargers, FLEXmax Charge Controllers, and an OutBack HUB Communications Manager.

It is designed in the following configurations:

- **GSLC** – GS Load Center for Radian Series. Recommended for custom-built systems. Recommended for use with multiple Radian inverters (one GSLC per inverter). Can be used with other inverter models. The term “GSLC” is also used to refer generically to the product line.
- **GSLC175-120/240** – GS Load Center for AC Applications (split-phase). Factory-prepared with dual 175 Adc inverter circuit breakers, dual AC inputs, and 120/240 Vac maintenance bypass assembly. Recommended for systems which have a single Radian inverter and an AC source, but can be customized in other ways.
- **GSLC175-230** – GS Load Center for AC Applications (single-phase). Factory-prepared with dual 175 Adc inverter circuit breakers, dual AC inputs, and 230 Vac maintenance bypass assembly. Recommended for systems which have a single Radian inverter and an AC source, but can be customized in other ways.
- **GSLC175-PV-120/240** – GS Load Center for PV and AC Applications (split-phase). Factory-prepared with dual 175 Adc inverter circuit breakers, dual AC inputs, 120/240 Vac maintenance bypass assembly, PV GFDI, and two PV array inputs, FLEXnet DC battery monitor and three shunts. Intended as a “plug-and-play” solution for systems with a single Radian inverter, two FLEXmax charge controllers, and battery monitoring.
- **GSLC175-PV-230** – GS Load Center for PV and AC Applications (single-phase). Factory-prepared with dual 175 Adc inverter circuit breakers, dual AC inputs, 230 Vac maintenance bypass assembly, PV GFDI, two PV array inputs, FLEXnet DC battery monitor, and three shunts. Intended as a “plug-and-play” solution for systems with a single Radian inverter, two FLEXmax charge controllers, and battery monitoring.



The enclosure provides mounting holes for the HUB Communications Manager and for up to two FLEXmax charge controller mounting brackets.

**NOTE:** OutBack FLEXmax Extreme charge controllers are mounted beside the inverter or the GSLC. The FLEXmax Extreme does not require additional mounting brackets. See the *Radian Series Installation Manual* for more information.

The removable front cover allows for opening from either side of the enclosure.

**Figure 1** **GS Load Center (GSLC)**

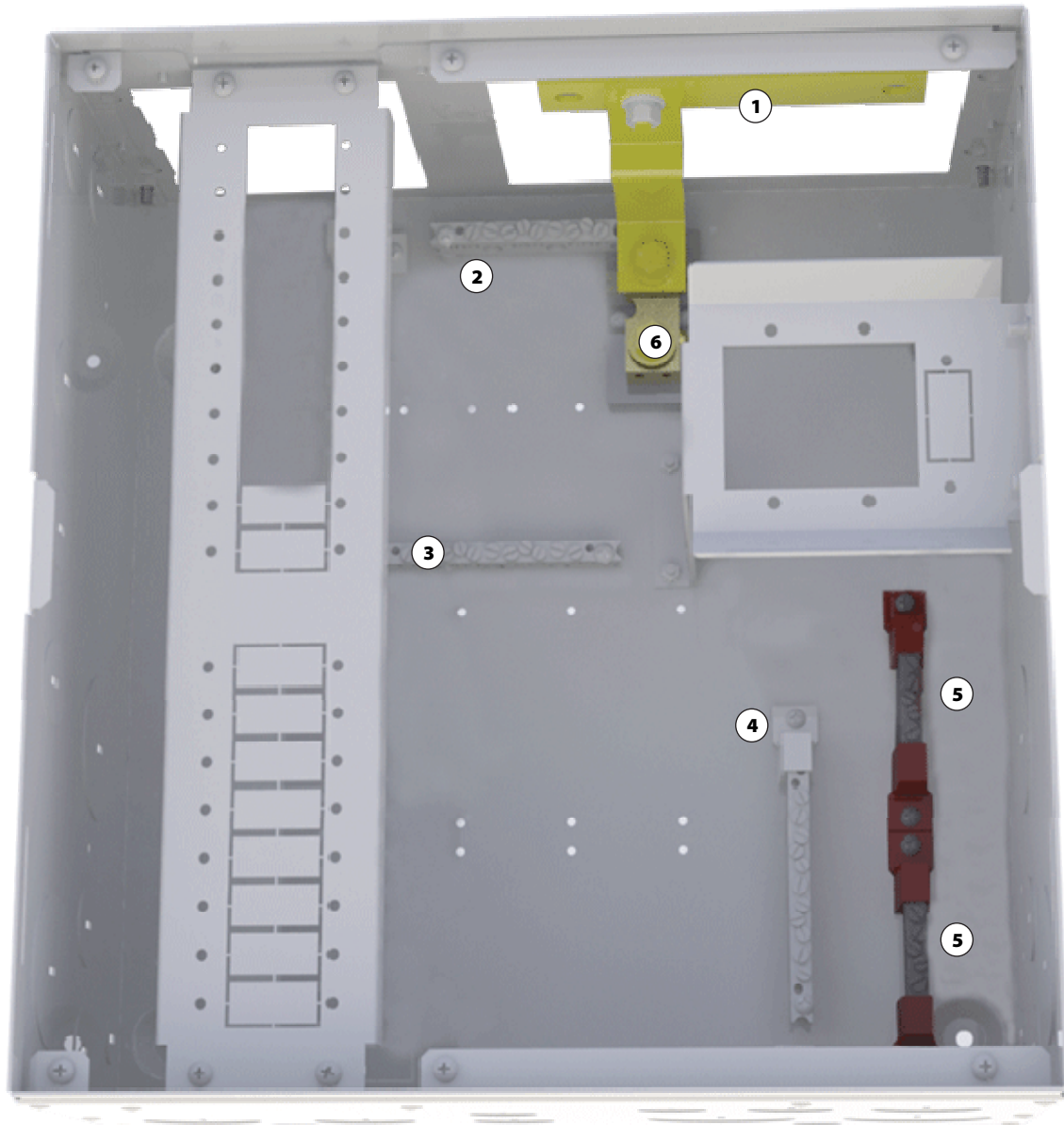
# GSLC – Components

## Legend

- ① Inverter (negative) DC Bus Bars
- ② Negative Terminal Bus Bar (TBB)
- ③ Ground TBB
- ④ Neutral TBB
- ⑤ PV (Positive) TBBs
- ⑥ Shunt

**NOTE:** The installed Neutral TBB has white insulators. A set of blue insulators is included in the kit for locations where blue is standard.

Inverter positive DC bus bars and DC positive bus plate are also included in the kit.

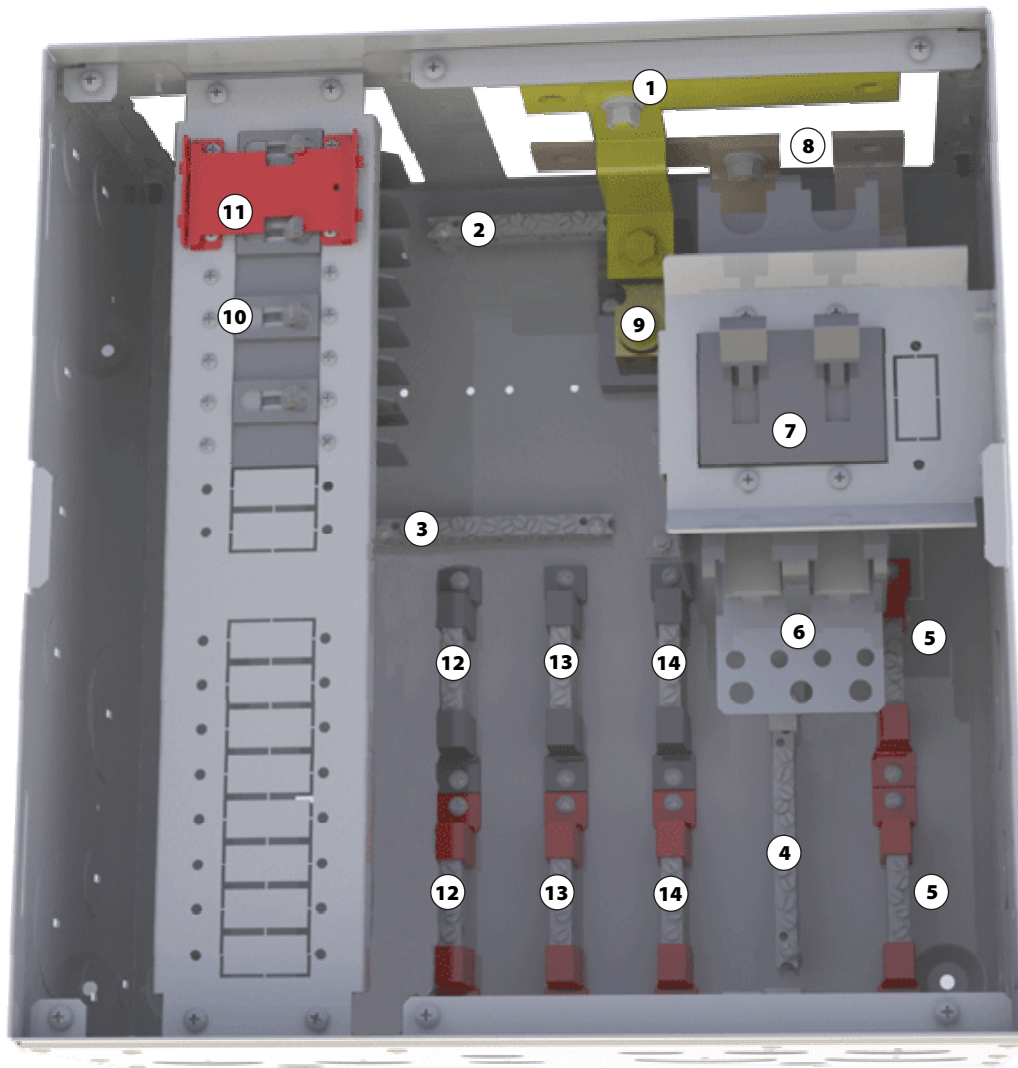


**Figure 2**      **GSLC Components**

## GSLC175-120/240 – Components

### Legend

- |                                   |                                   |
|-----------------------------------|-----------------------------------|
| ① Inverter (negative) DC Bus Bars | ⑧ Inverter (positive) DC Bus Bars |
| ② Negative Terminal Bus Bar (TBB) | ⑨ Shunt                           |
| ③ Ground TBB                      | ⑩ AC Circuit Breakers             |
| ④ Neutral TBB                     | ⑪ Maintenance Bypass Interlock    |
| ⑤ PV TBB                          | ⑫ AC TBB (Inverter Output) L1, L2 |
| ⑥ DC Positive Cable Plate         | ⑬ AC TBB (Grid) L1, L2            |
| ⑦ Main Inverter Disconnect(s)     | ⑭ AC TBB (Generator) L1, L2       |



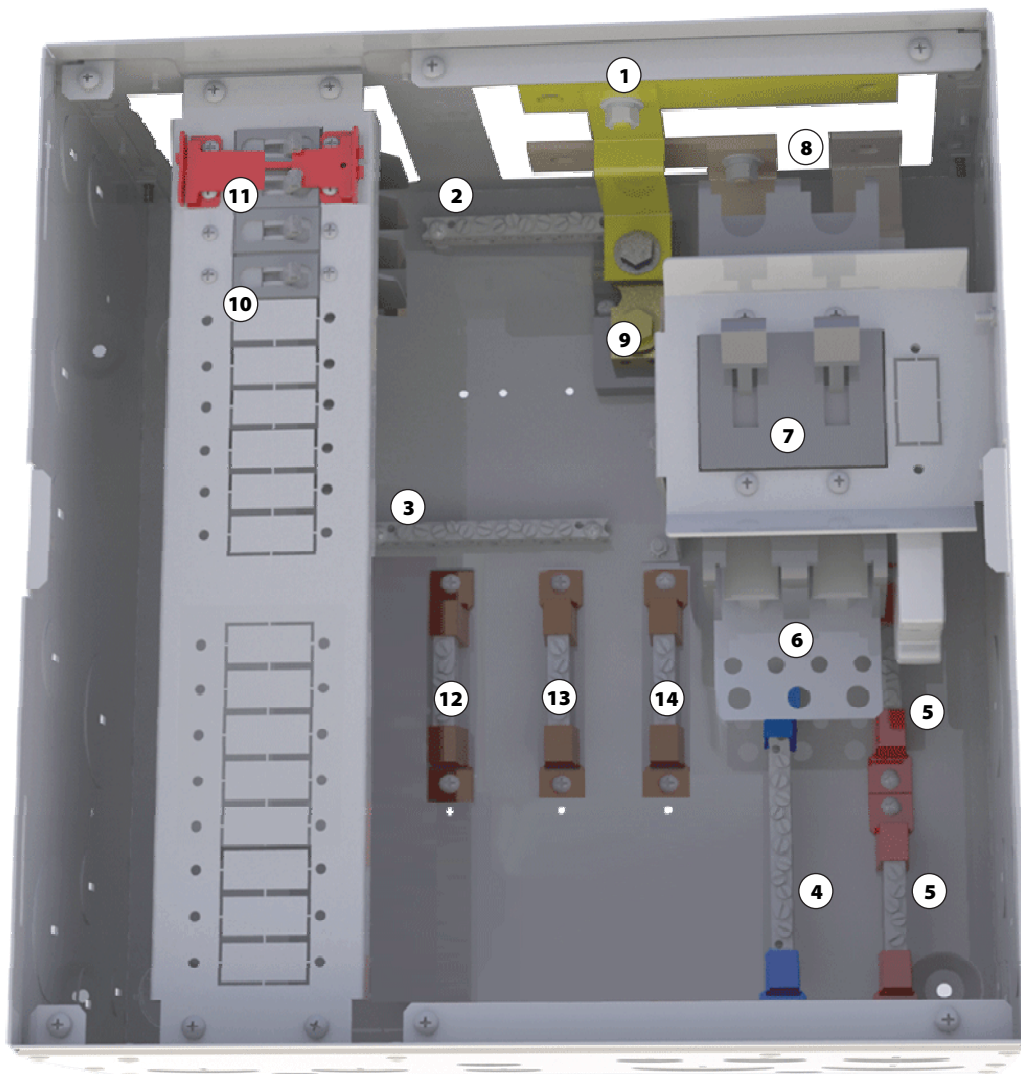
**NOTE:** The factory wiring has been omitted from this illustration for clarity.

**Figure 3** **GSLC175-120/240 Components**

# GSLC175-230 – Components

## Legend

- |                                   |                                   |
|-----------------------------------|-----------------------------------|
| ① Inverter (negative) DC Bus Bars | ⑧ Inverter (positive) DC Bus Bars |
| ② Negative Terminal Bus Bar (TBB) | ⑨ Shunt                           |
| ③ Ground TBB                      | ⑩ AC Circuit Breakers             |
| ④ Neutral TBB                     | ⑪ Maintenance Bypass Interlock    |
| ⑤ PV TBB                          | ⑫ AC TBB (Inverter Output)        |
| ⑥ DC Positive Cable Plate         | ⑬ AC TBB (Grid)                   |
| ⑦ Main Inverter Disconnect(s)     | ⑭ AC TBB (Generator)              |



**NOTE:** The factory wiring has been omitted from this illustration for clarity.

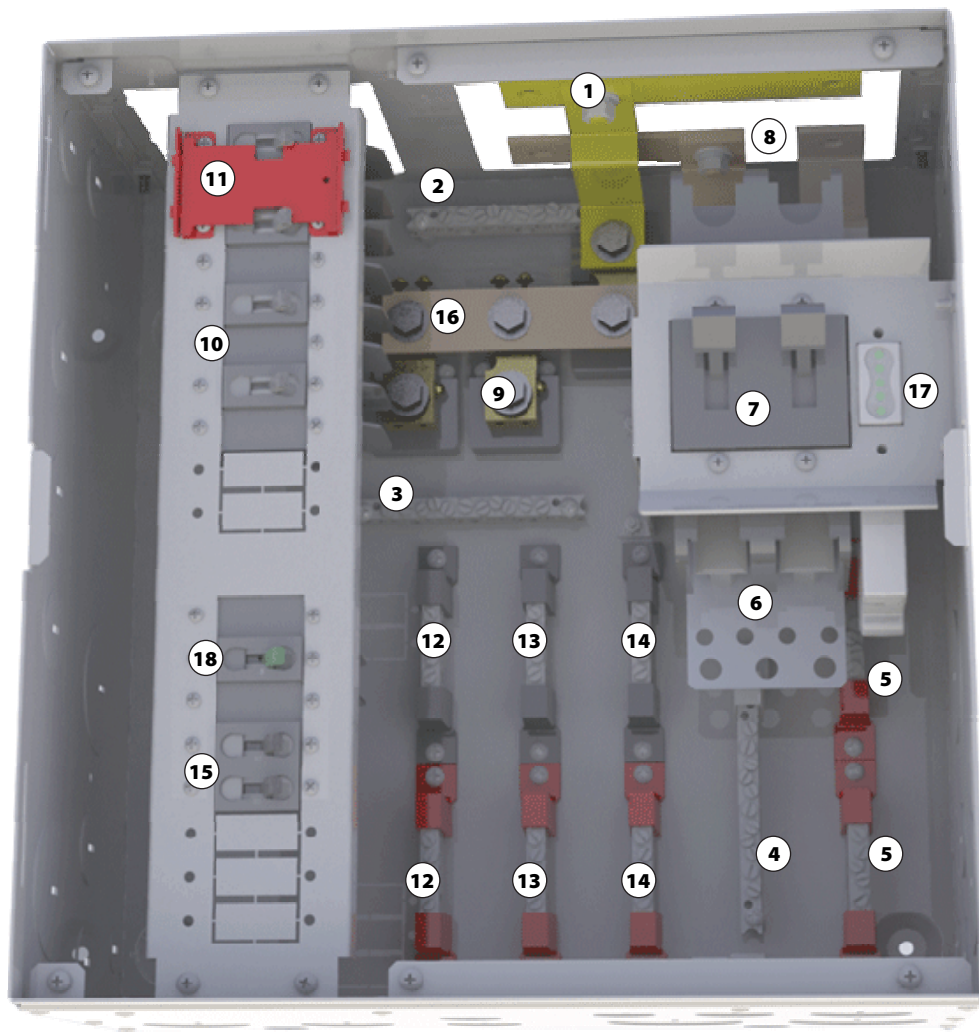
**Figure 4** **GSLC175-230 Components**



# GSLC175-PV-120/240 – Components

## Legend

- |                                   |                                    |
|-----------------------------------|------------------------------------|
| ① Inverter (negative) DC Bus Bars | ⑩ AC Circuit Breakers              |
| ② Negative Terminal Bus Bar (TBB) | ⑪ Maintenance Bypass Interlock     |
| ③ Ground TBB                      | ⑫ AC TBBs (Inverter Output) L1, L2 |
| ④ Neutral TBB                     | ⑬ AC TBBs (Grid) L1, L2            |
| ⑤ PV TBBs                         | ⑭ AC TBBs (Generator) L1, L2       |
| ⑥ DC Positive Cable Plate         | ⑮ PV Input Disconnects             |
| ⑦ Main Inverter Disconnect(s)     | ⑯ Shunt Bus                        |
| ⑧ Inverter (positive) DC Bus Bars | ⑰ FLEXnet DC                       |
| ⑨ Shunt(s)                        | ⑱ PV GFDI                          |



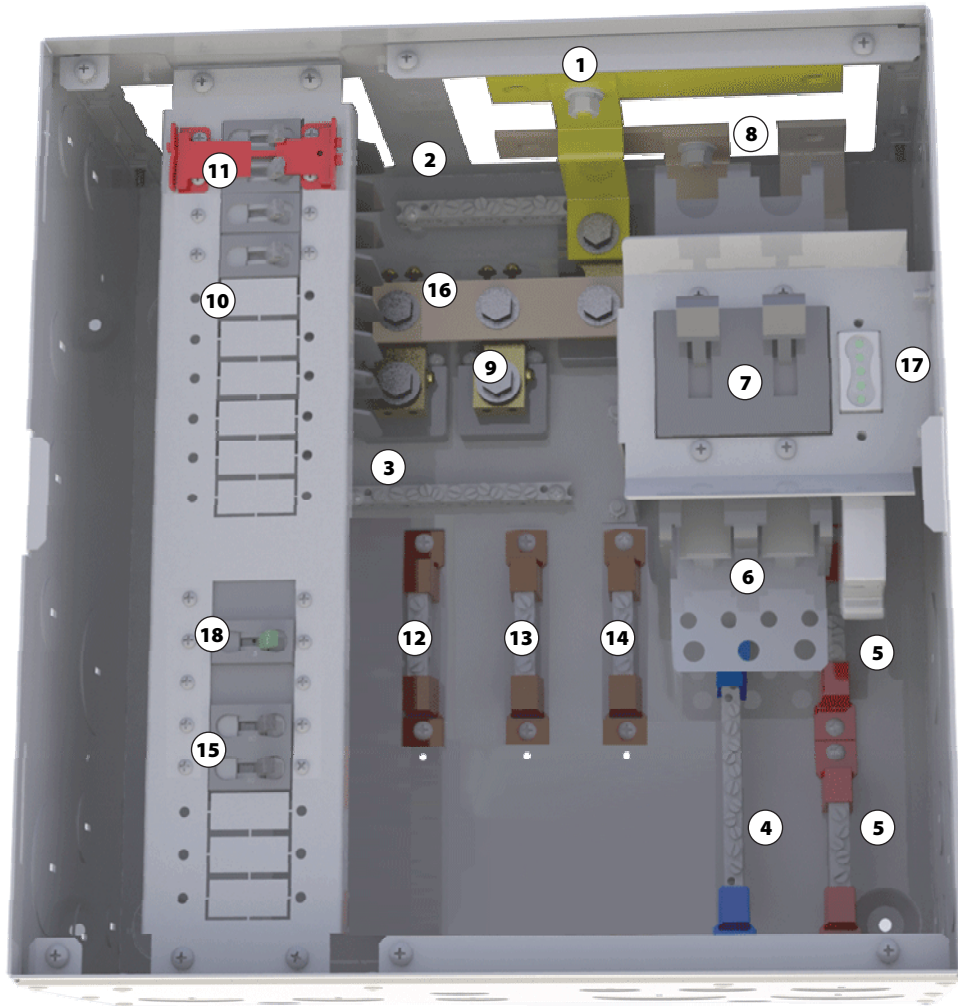
**NOTE:** The factory wiring has been omitted from this illustration for clarity.

**Figure 5** **GSLC175-PV-120/240 Components**

# GSLC175-PV-230 – Components

## Legend

- |                                   |                                |
|-----------------------------------|--------------------------------|
| ① Inverter (negative) DC Bus Bars | ⑩ AC Circuit Breakers          |
| ② Negative Terminal Bus Bar (TBB) | ⑪ Maintenance Bypass Interlock |
| ③ Ground TBB                      | ⑫ AC TBB (Inverter Output)     |
| ④ Neutral TBB                     | ⑬ AC TBB (Grid)                |
| ⑤ PV TBB                          | ⑭ AC TBB (Generator)           |
| ⑥ DC Positive Cable Plate         | ⑮ PV Input Disconnects         |
| ⑦ Main Inverter Disconnect(s)     | ⑯ Shunt Bus                    |
| ⑧ Inverter (positive) DC Bus Bars | ⑰ FLEXnet DC                   |
| ⑨ Shunt(s)                        | ⑱ PV GFDI                      |



**NOTE:** The factory wiring has been omitted from this illustration for clarity.

**Figure 6**      **GSLC175-PV-230 Components**



# Planning

## Tools Required

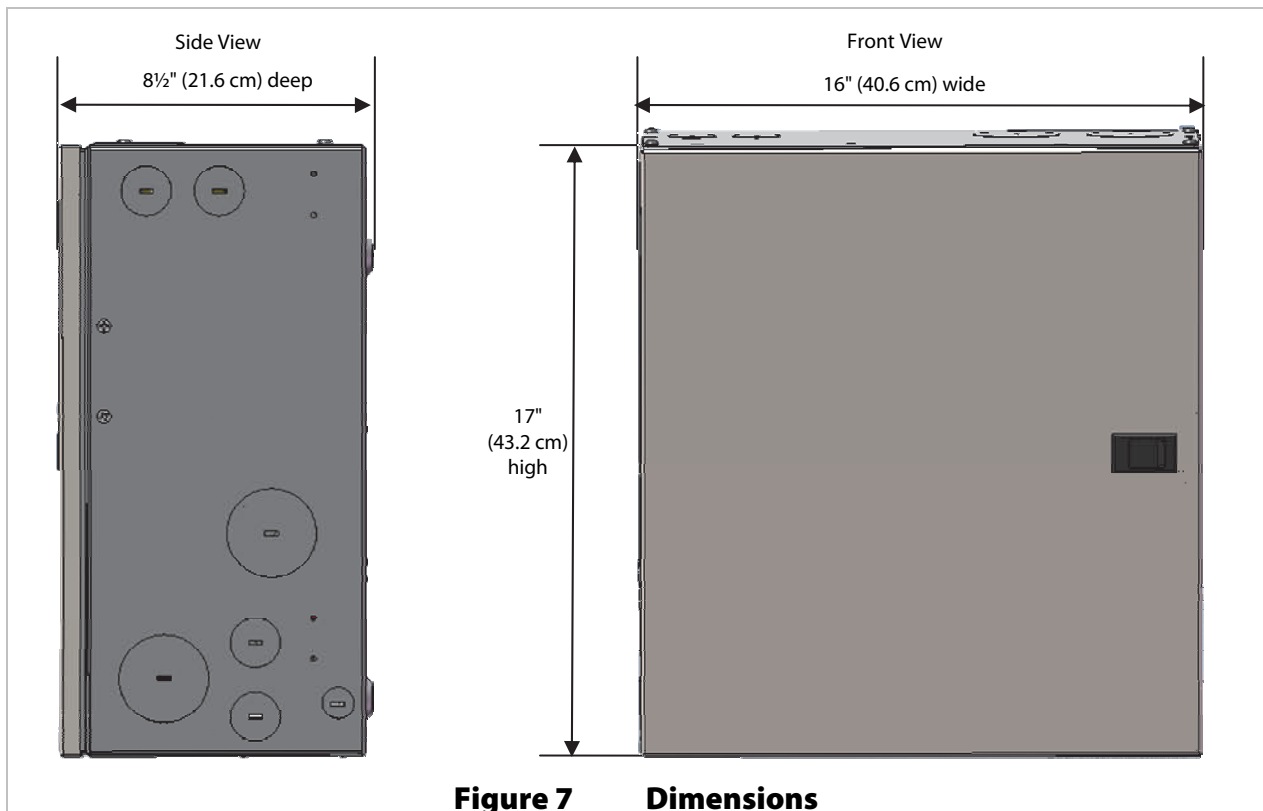
- Open-ended wrenches (9/16" and 13 mm)
- Wire cutters/strippers
- Torque wrenches
- Assorted insulated screwdrivers
- Digital Voltmeter (DVM) or regular voltmeter

## Materials Required

- Conductors for wiring
- Conduits

## Location/Environmental Requirements

- Indoor mount only

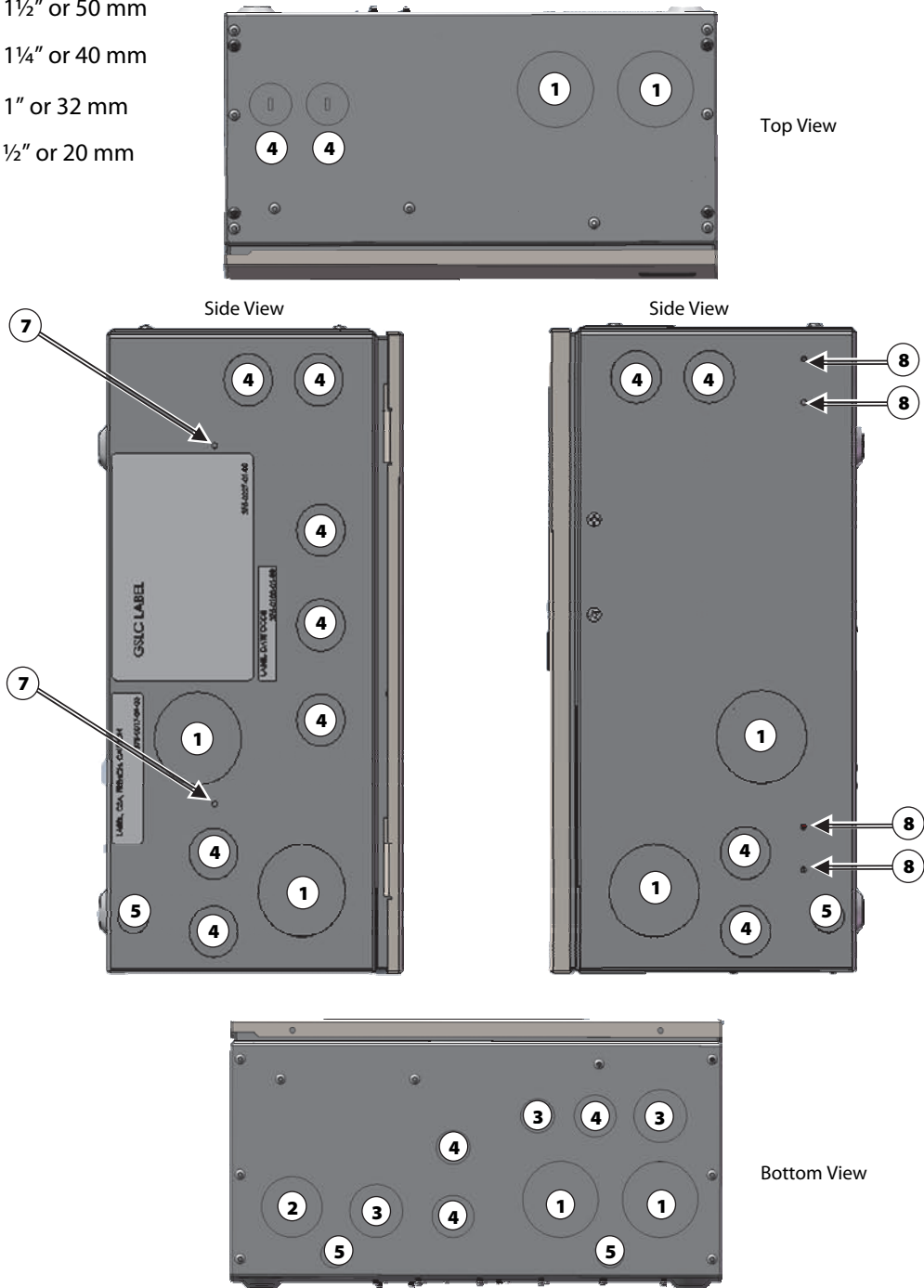


## Legend

### Cable Knockouts (U.S. Trade Size or Metric Trade Size)

- ① 2" or 63 mm
- ② 1½" or 50 mm
- ③ 1¼" or 40 mm
- ④ 1" or 32 mm
- ⑤ ½" or 20 mm

- ⑦ Mounting holes for HUB
- ⑧ Mounting holes for FW-CCB and CCB2 brackets



**Figure 8 Knockouts and Mounting Holes for FLEXmax and HUB**



# Installation

## Hardware Options

The five versions of the GSLC come with different components already installed.

- **GSLC**, the “basic” or “empty” version, requires almost all components to be installed if they are needed. Instructions for this product begin on page 13.
- **GSLC175-120/240** and **GSLC175-230**, the “AC only” versions, require certain components to be installed if they are needed. Instructions for these products begin with the DC shunts, on page 17.
- **GSLC175-PV-120/240** and **GSLC175-PV-230**, the “fully-loaded” versions, have all components already present and need only to have external wiring and devices added. Users with either of these versions can skip to the wiring section on page 23.

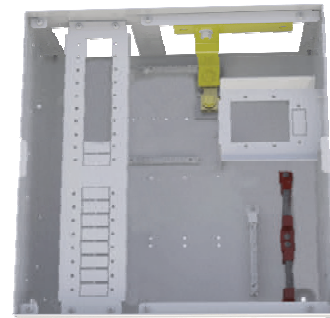
Additional AC and DC circuit breakers are available for installation on all models.

The following pages describe the installation of individual items, including the removal of the GSLC covers. Page 13 lists the hardware requirements for these items.

- Instructions for Radian inverter mounting (along with other devices) begin on page 19.
- Instructions for installing the FLEXnet DC battery monitor begin on page 26.
- Instructions for installing the AC input-output bypass (IOB) assembly begin on page 34.

### The following components are sold separately for the GSLC:

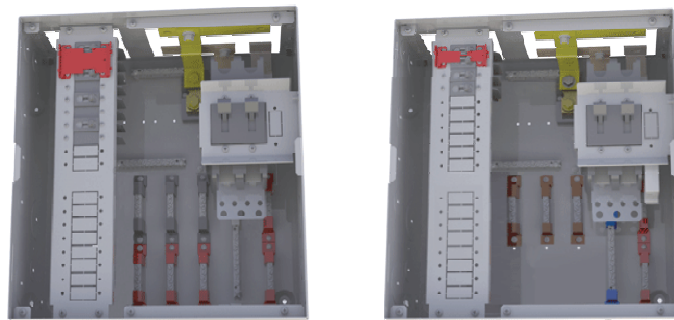
- Inverter Main Disconnects (required for inverter installations)
- DC Positive Cable Plate
- AC Maintenance Bypass Assembly
- AC Terminal Bus Bars (TBB)
- PV Ground Fault Detector-Interrupter (GFDI)
- FLEXnet DC Battery Monitor (see page 26)
- Additional DC shunts and GS-SBUS



**Figure 9** GSLC – Additional Components

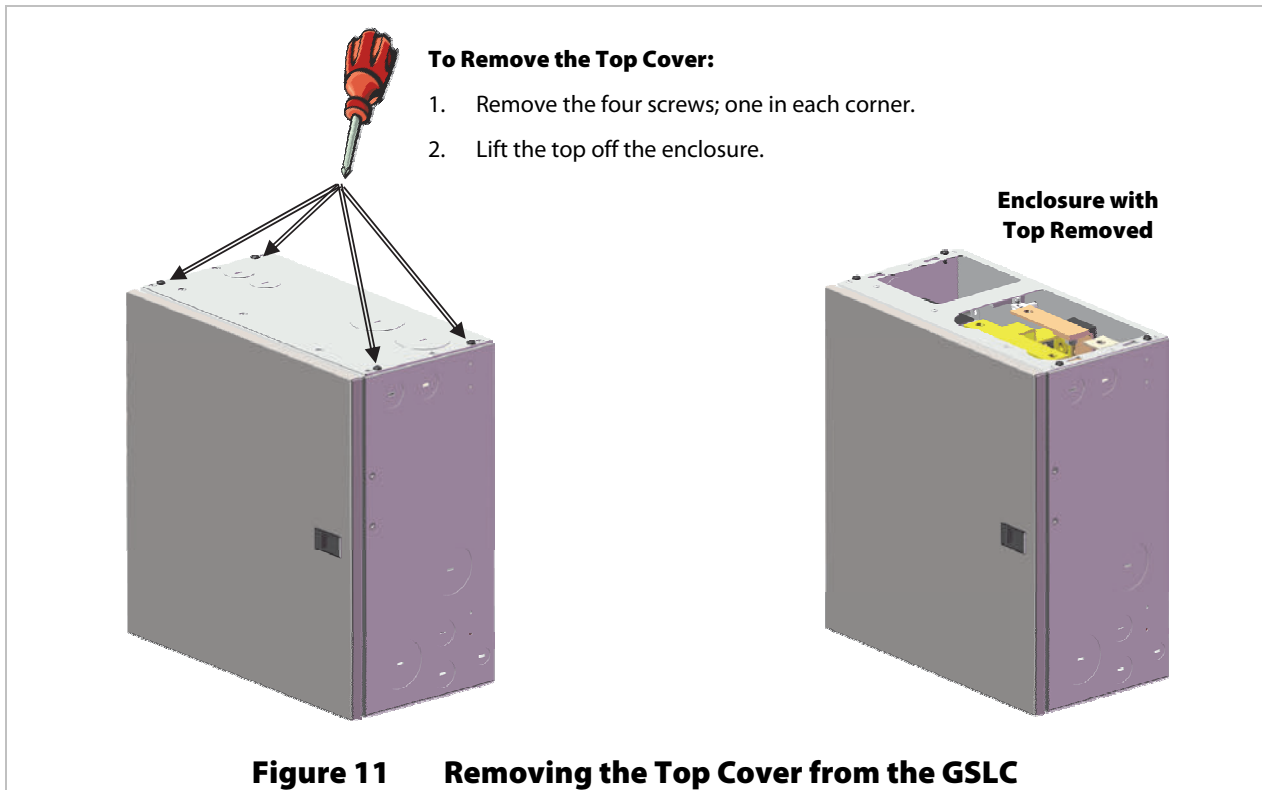
### The following components are sold separately for the GSLC175-120/240 and GSLC175-230:

- PV Ground Fault Detector-Interrupter (GFDI)
- FLEXnet DC Battery Monitor (see page 26)
- Additional DC shunts and GS-SBUS

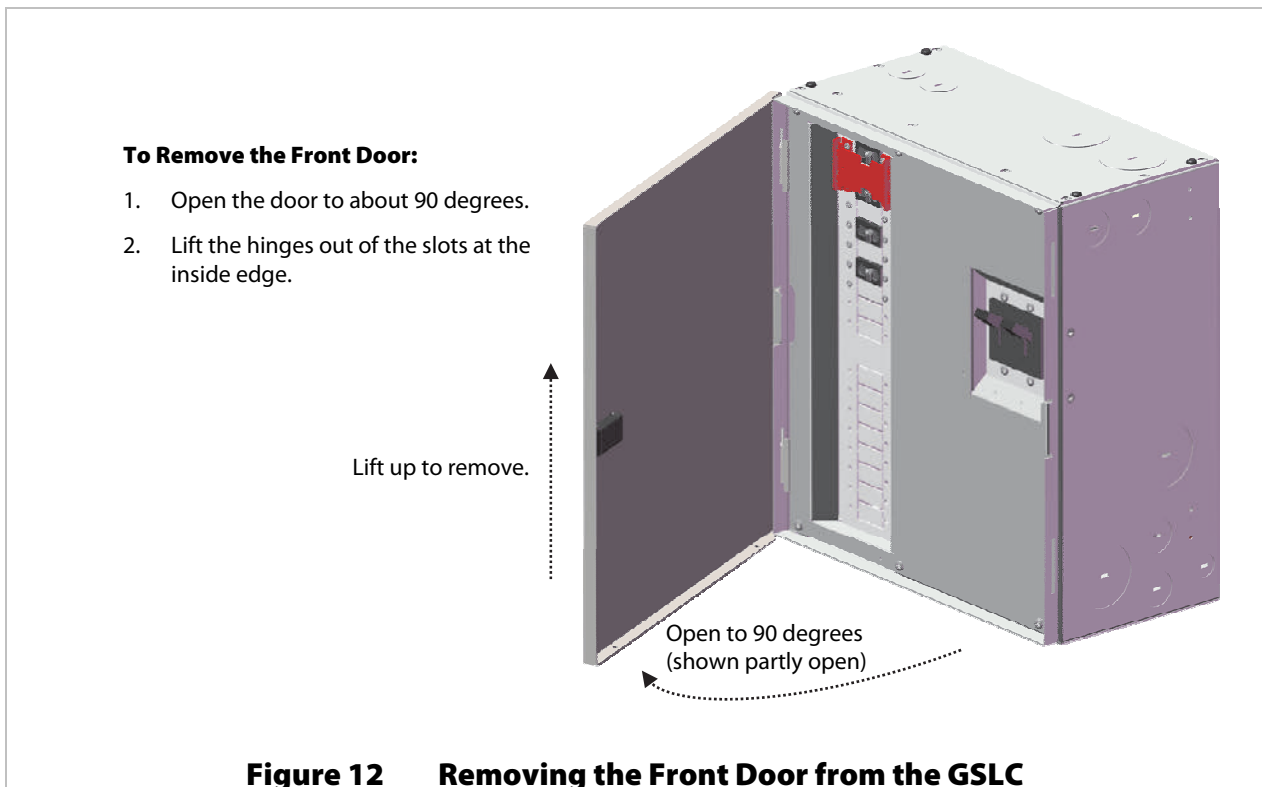


**Figure 10** GSLC175-120/240 and GSLC175-230 – Additional Components

## Remove Top Cover



## Remove Front Door

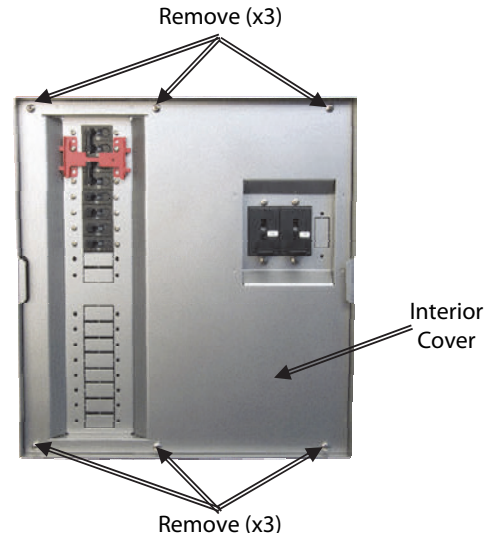


## Remove Interior Cover

In order to make any wiring connections or install components, the interior cover must be removed to expose the interior of the enclosure.

**To Remove the Interior Cover:**

1. Remove the three screws along the top of the enclosure (with one star washer).
2. Remove the three screws along the bottom of the enclosure (with one star washer).
3. Lift the front cover off the enclosure.

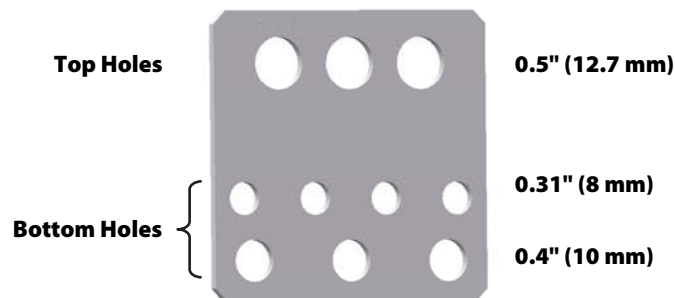


**Figure 13 Removing the Interior Cover from the GSLC**

## Installing the Internal Hardware

**Table 1 Bus Bar and Circuit Breaker Size and Torque Requirements**

Item	Terminal/Bolt Size	Torque Requirements
Inverter Positive Bus Bars	M8	60 in-lb (6.8 Nm)
Shunt Bolts	3/8"	60 in-lb (6.8 Nm)
DC Positive Cable Plate	Top Holes (x3)	60 in-lb (6.8 Nm)
	Bottom Holes (x7)	50 in-lb (5.7 Nm)
Circuit Breaker Studs	M8	20 in-lb (2.3 Nm)
	1/4"	35 in-lb (4.0 Nm)
	5/16"	50 in-lb (5.7 Nm)
	3/8"	225 in-lb (25.5 Nm)



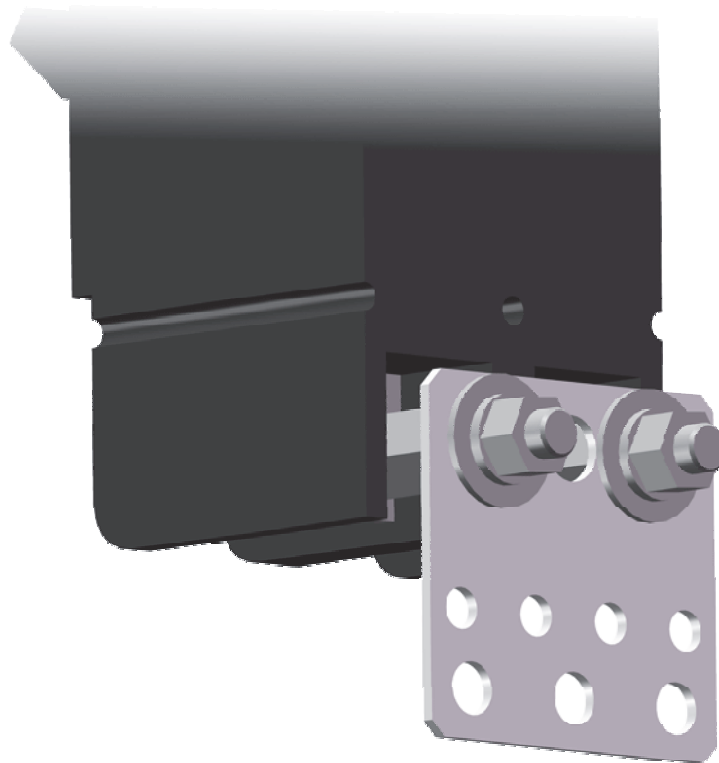
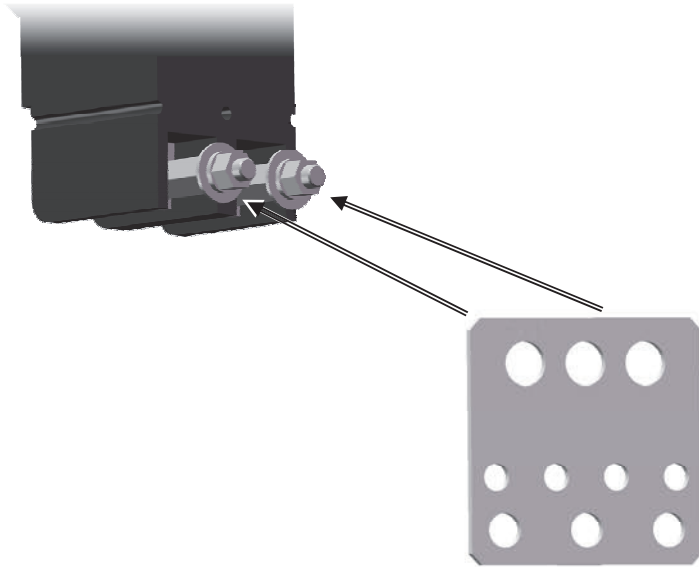
**Figure 14 DC Positive Cable Plate**

## Assembling DC Positive Cable Plate

The bottom of each DC disconnect is bolted to a bus plate which receives the inverter's positive (+) battery cables.

### To assemble the DC Positive Plate:

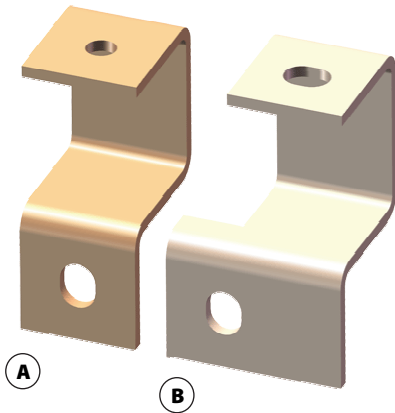
1. Remove the nuts and other hardware (washer, lock washer, hex nut) from the bottom terminal in the back of each DC disconnect.
2. Place the two disconnects side by side.
3. Orient the DC positive plate so that the three largest holes are at the top. These holes have a diameter of 0.50" (1.3 cm). Insert the studs on each disconnect through the first and third holes.
4. Replace the disconnect hardware (washer, lock washer, hex nut). Tighten the nuts to the values shown in Table 1 on page 13. The plate will hold the two breakers together as a set.



**Figure 15** Assembling the DC Positive Cable Plate



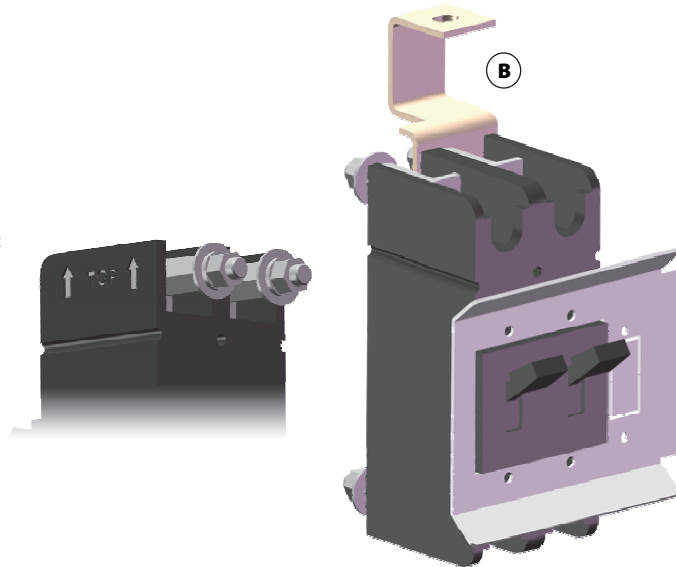
## Installing Inverter Positive Bus Bars



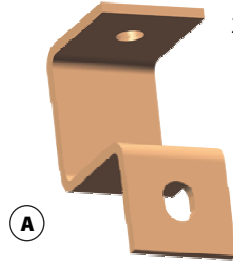
The GSLC parts kit contains two bus bars, **(A)** and **(B)**, which attach to the tops of the DC disconnects. These bus bars make the connections with the Radian inverter's positive DC terminals. Although they have similar shapes, the bus bars are not interchangeable.

### To assemble the Inverter Positive (+) Bus Bars:

1. Attach bus bar **(B)** to the top terminal of the disconnect on the right, using the stud and hardware on the back of the disconnect. Tighten the nuts to the values shown in Table 1 on page 9.

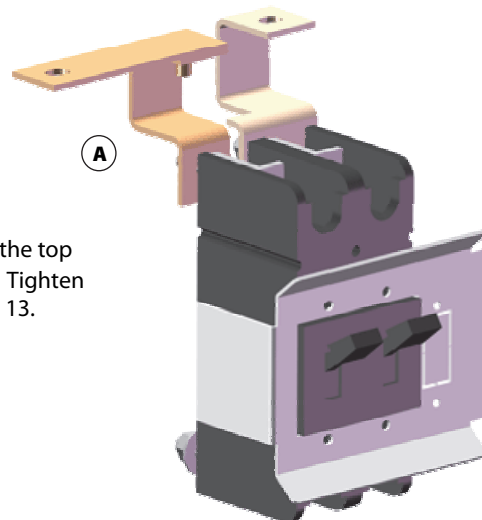


Top Bar



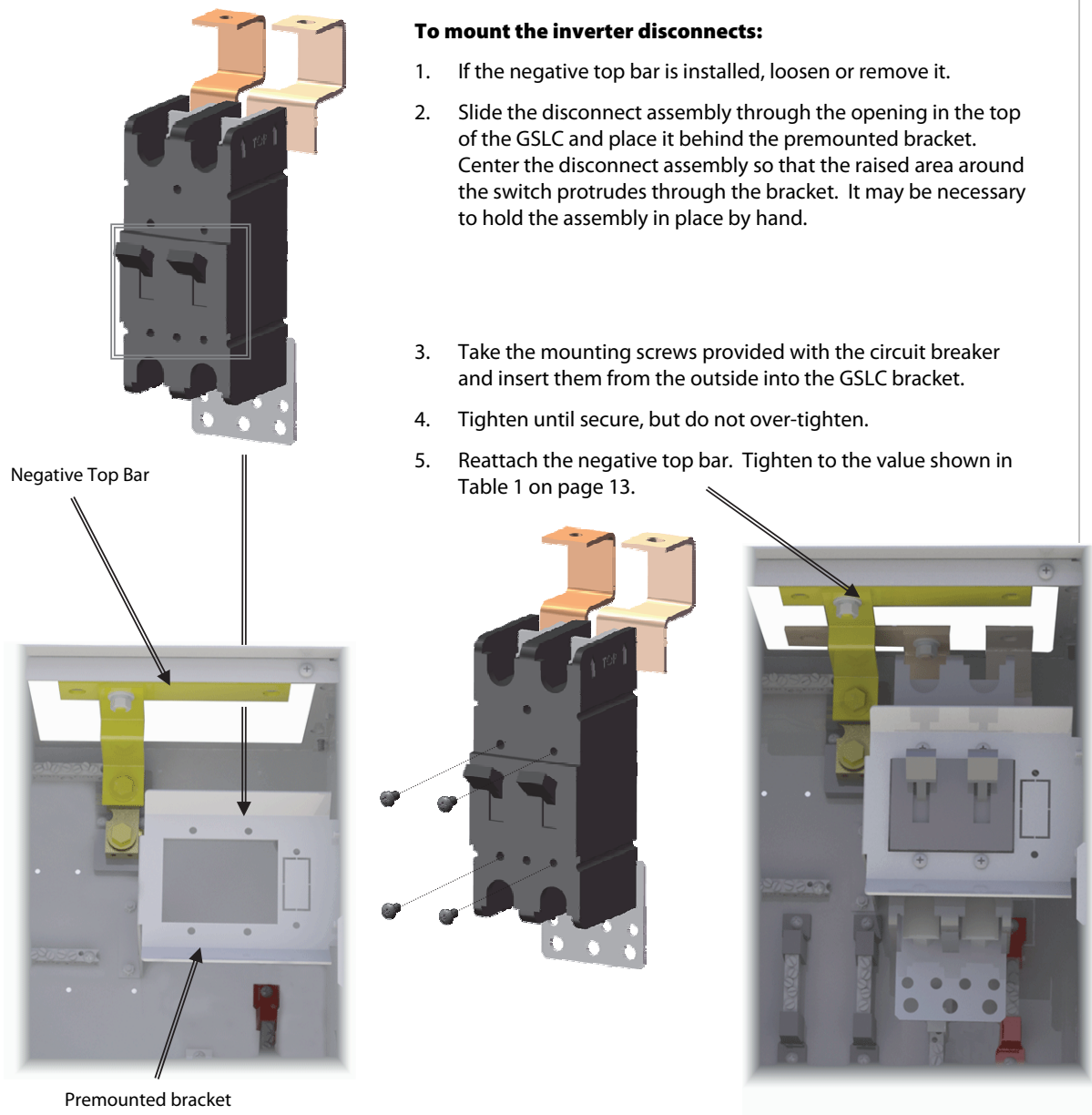
2. The GSLC's hardware kit contains a top bar which attaches to bus bar **(A)**. Attach these two bars together using a 5/16" flat washer, a 5/16" lock washer, and an M8 nut (included in hardware kit). Tighten to the value shown in Table 1 on page 13.

3. Mount bus bar **(A)** and the top bar to the top terminal of the disconnect on the left. Tighten to the value shown in Table 1 on page 13.



**Figure 16 Inverter Bus Bars**

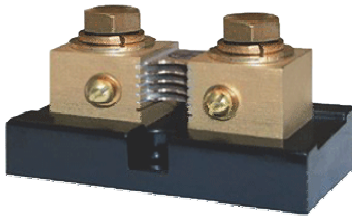
## Installing Inverter Main Disconnects



These instructions assume that the GSLC has not yet been mounted to the Radian inverter and that the top is open. If the GSLC's top is closed or inaccessible, remove the premounted bracket. Attach the disconnect assembly to it. Finally, re-install the bracket.

**Figure 17 Inverter Main Disconnects**

## Installing DC Shunts

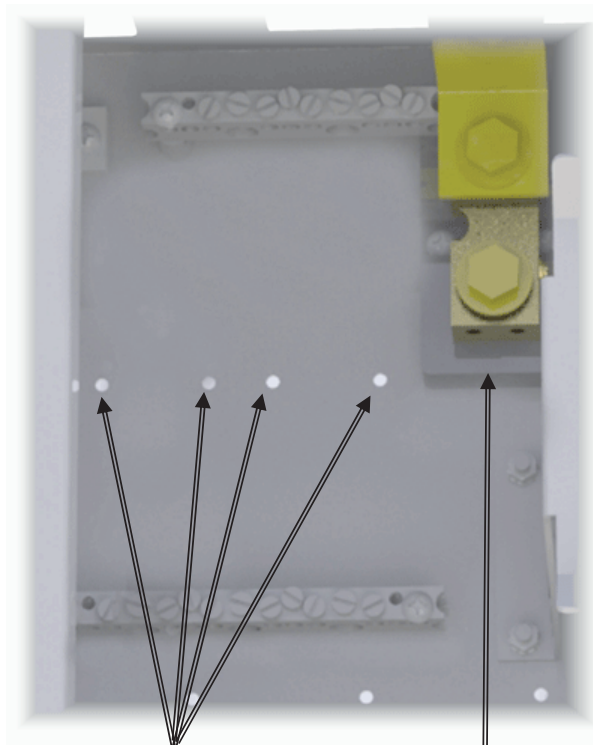


A single 500 Adc/50 mV shunt is included with the GSLC. Up to two more shunts can be installed as needed. These shunts are used in conjunction with the FLEXnet DC battery monitor. See page 25 for more instructions on wiring.

**To mount DC Shunts:**

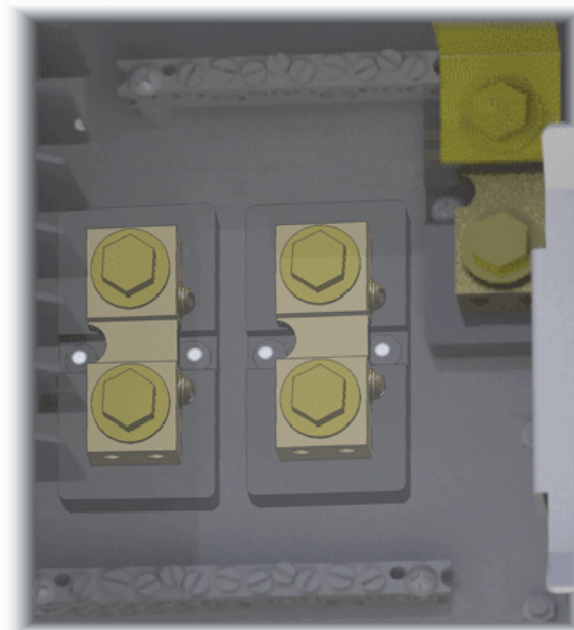
1. Four mounting holes are located to the lower left of the first shunt. Center each shunt across one pair of mounting holes. These should line up with the mounting holes built into each shunt.
2. Using the screws included with the shunt, attach each shunt to the GSLC enclosure.
3. Tighten the screws until secure, but do not over-tighten.

**NOTE:** The GS-SBUS can be purchased and installed to connect the three shunts together. See Figure 27 on page 26.



Mounting Holes for Additional Shunts

Pre-installed Shunt



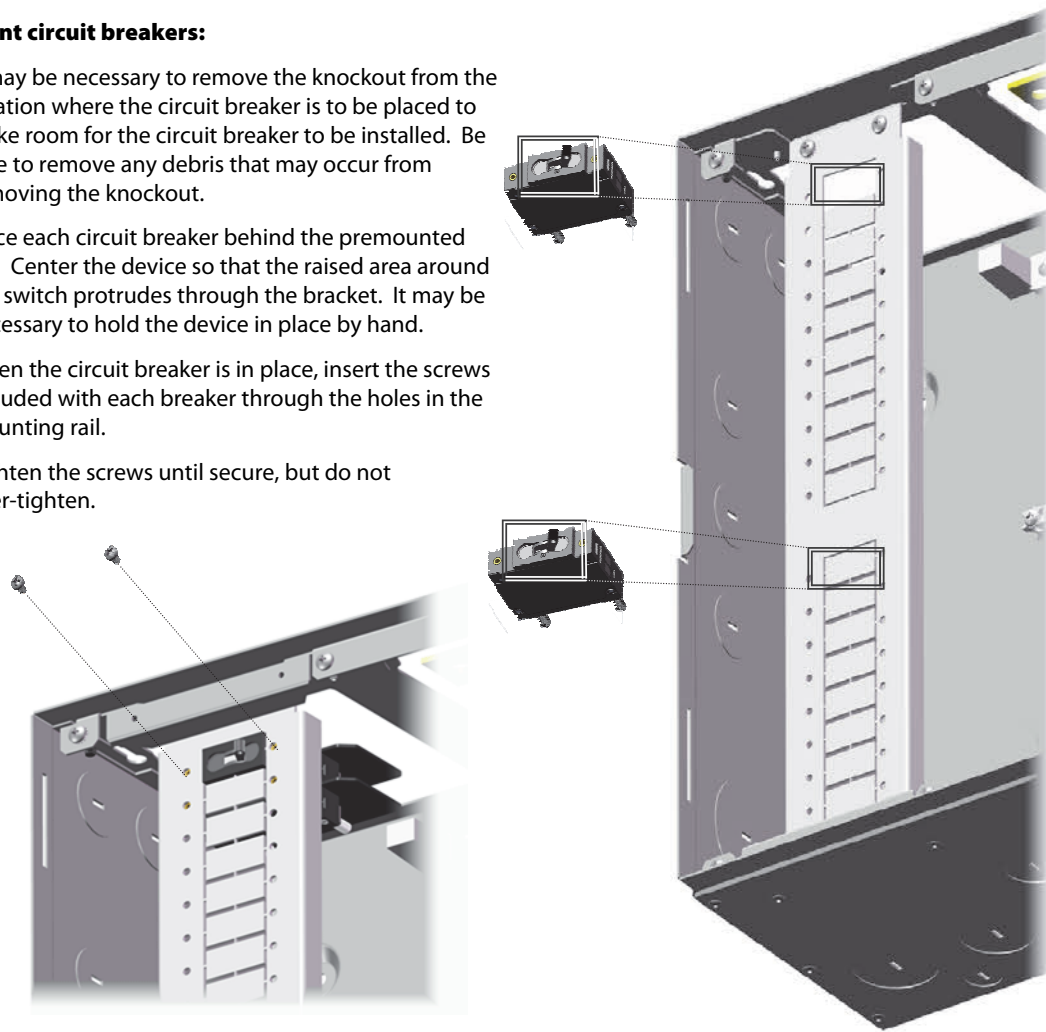
Additional Shunt Placement

**Figure 18 DC Shunts**

## Installing PV and AC Circuit Breakers and GFDI

### To mount circuit breakers:

1. It may be necessary to remove the knockout from the location where the circuit breaker is to be placed to make room for the circuit breaker to be installed. Be sure to remove any debris that may occur from removing the knockout.
2. Place each circuit breaker behind the premounted rail. Center the device so that the raised area around the switch protrudes through the bracket. It may be necessary to hold the device in place by hand.
2. When the circuit breaker is in place, insert the screws included with each breaker through the holes in the mounting rail.
3. Tighten the screws until secure, but do not over-tighten.



### NOTES

- Although there are no specific designations, the upper end of the mounting rail is generally used for AC devices (including the maintenance bypass). The lower end is generally used for DC devices, including the GFDI. The preassembled GSLC models follow this convention.
- A PV ground-fault device may be required. The OutBack GFDI is pre-installed on some models. With other models it can be purchased separately for manual installation. (See page 11.) The GFDI mounts the same way as other circuit breakers. Once mounted, see page 27 and the GFDI manual for wiring instructions. (Note that the GFCI usually requires multiple rail slots.)
- Some installations may require an AC maintenance bypass. This is referred to as the Input-Output Bypass or IOB. The bypass comes prewired for a single Radian inverter in some GSLC versions. It can also be purchased separately. See page 29 and the GS-IOB manual for mounting and wiring instructions.

**Figure 19** Circuit Breakers

## Mounting on the Inverter



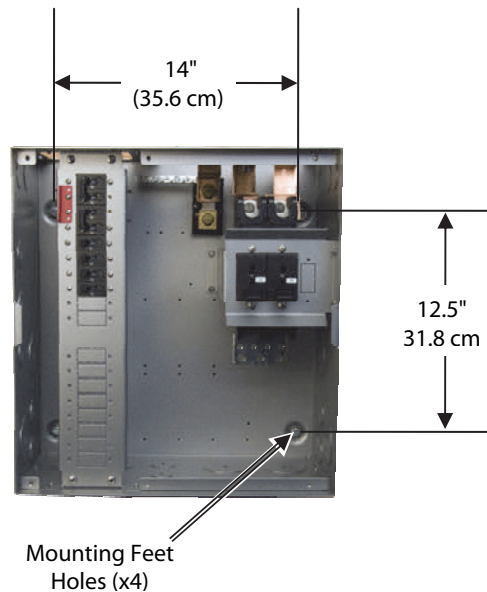
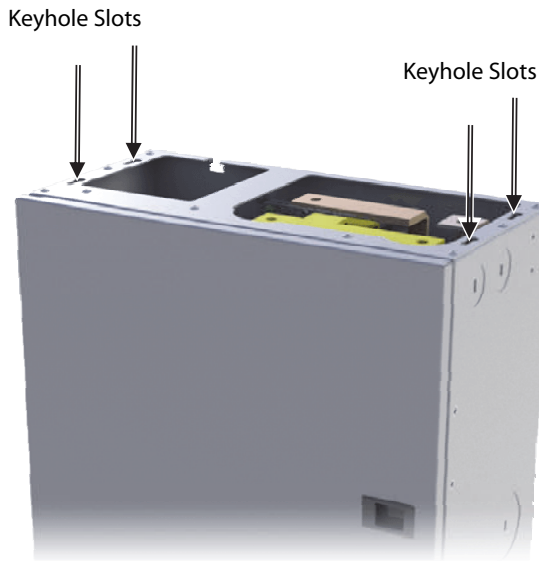
**IMPORTANT:**

The Radian inverter and GSLC are intended for indoor use only. Ensure that the mounting surface is strong enough to support the full weight of the Radian inverter/charger and the GSLC. Use a minimum 3/4" (19 mm) sheet of plywood to strengthen the wall surface if required.



**To mount the GSLC to the Radian inverter:**

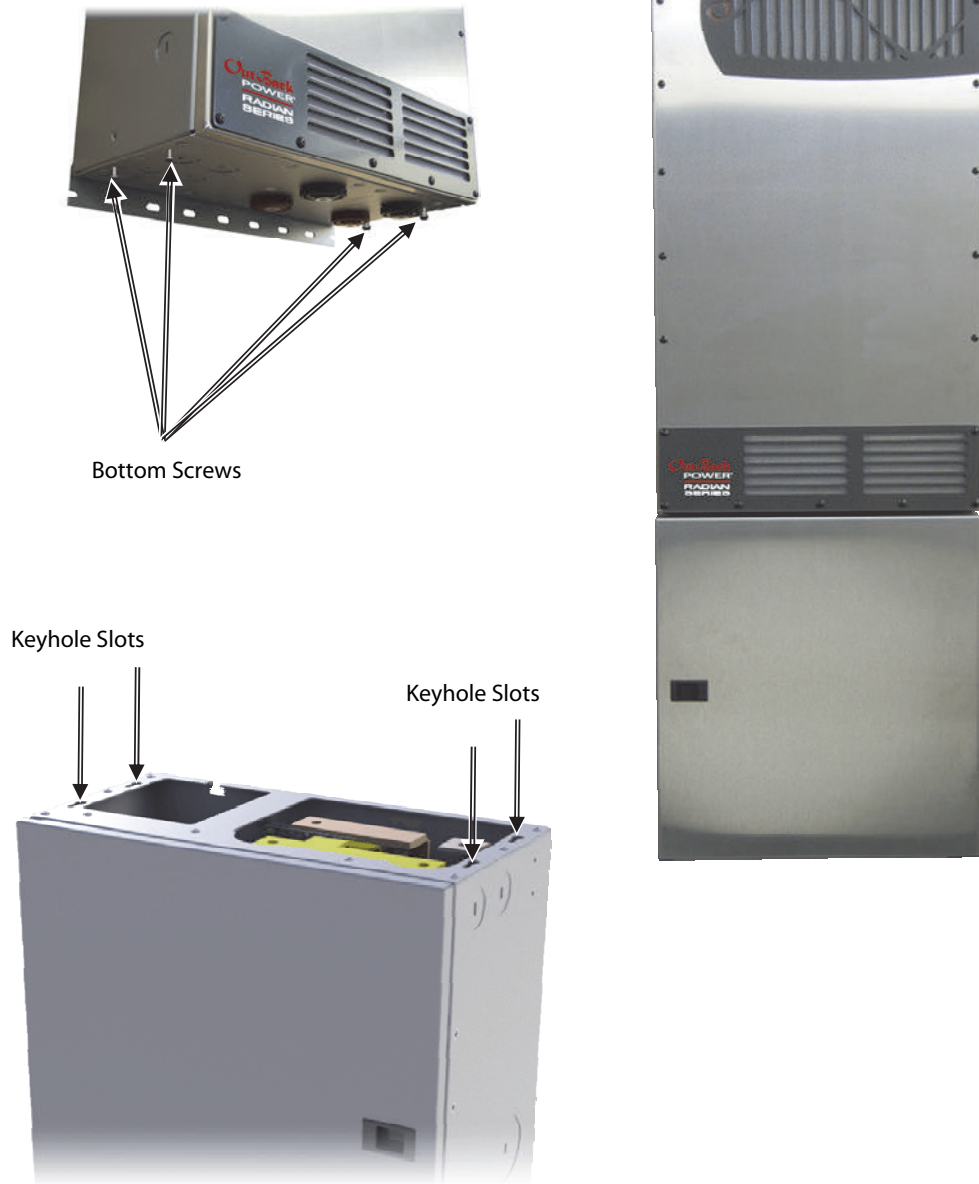
1. Install the Radian inverter onto the mounting bracket as instructed in the *Radian Series Inverter/Charger Installation Manual*.
2. Back out bottom screw(s) approximately 1/4" (0.6 cm) to 3/16" (0.5 cm).
3. Remove the front and interior covers from the GSLC if necessary (as described on page 12).
4. Align the GSLC along the bottom of the inverter and slide the bottom screws into the keyhole slots.
5. Hanging the GSLC from the screws and holding it flush against the bottom of the inverter, mark the spots for the holes for the mounting feet. These are located in the rear of the GSLC and are marked below.
6. If using wall anchors (included): Remove the GSLC. Using a 3/8" (10 mm) drill bit, drill leader holes for the hardware to be used to secure the GSLC to the surface. Install the wall anchors. If mounting on a solid surface like plywood, this step can be skipped.



Continued on the next page...

**Figure 20 Mounting the GSLC**

...continued from the previous page.



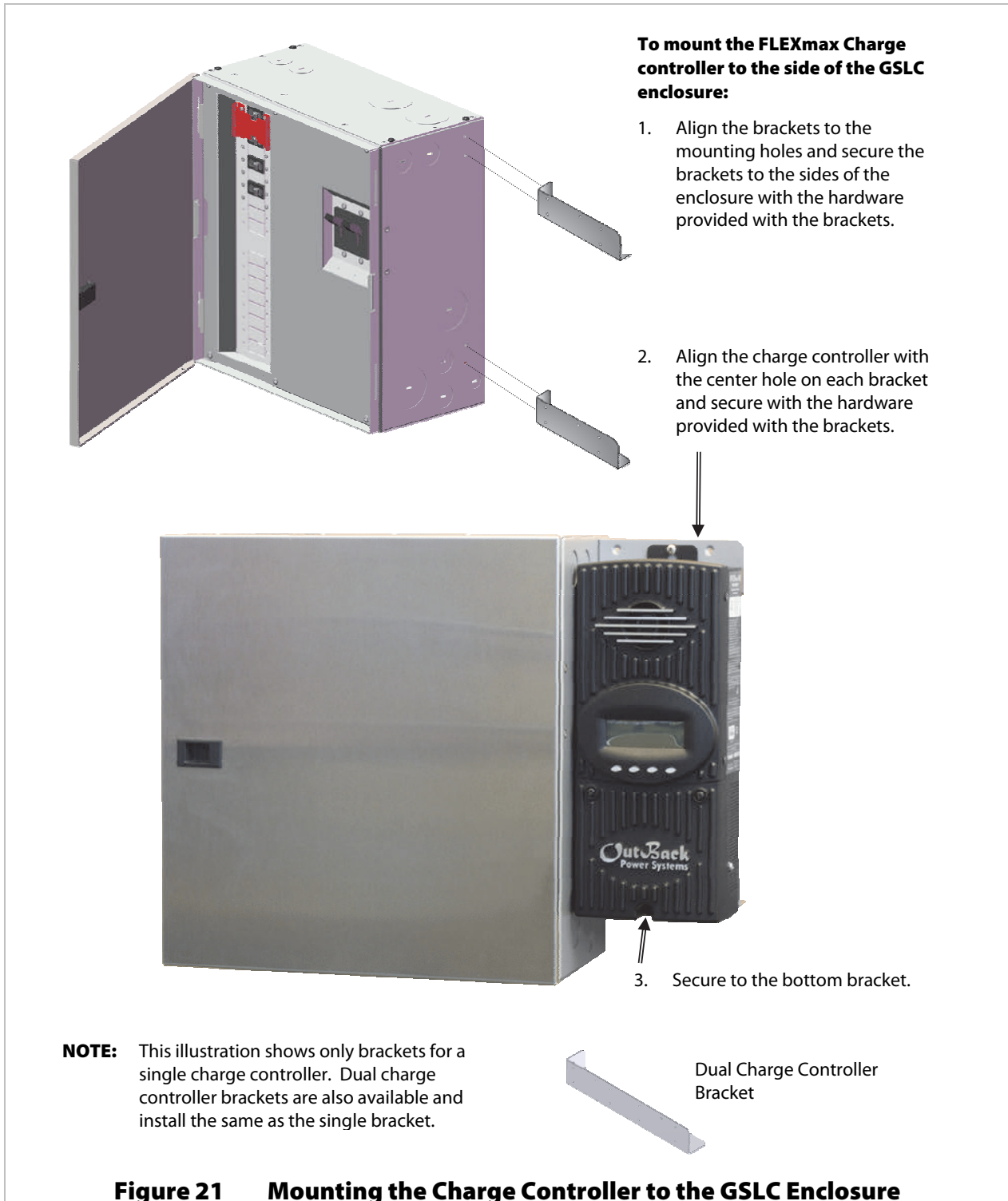
7. Realign the GSLC along the bottom of the inverter and slide the mounting screws into the keyhole slots.
8. Secure the enclosure to the mounting surface using all four mounting feet holes.
9. Using the bolts provided on the Radian inverter's battery terminals, connect the terminals to the GSLC's inverter bus bars. Tighten to the value shown in Table 1 on page 13. For more information on the Radian terminals, see the *Radian Series Inverter/Charger Installation Manual*.)
10. Leave the door and interior cover removed until all components have been installed and all wiring is complete.

**Figure 20 Mounting the GSLC (continued)**

## Mounting FLEXmax Charge Controller

The GSLC enclosure accommodates up to two FLEXmax charge controllers and a HUB Communications Manager.

**NOTE:** The following instructions are for the FLEXmax 60 or FLEXmax 80 only. The FLEXmax Extreme charge controller connects directly to the wall and does not need additional brackets.

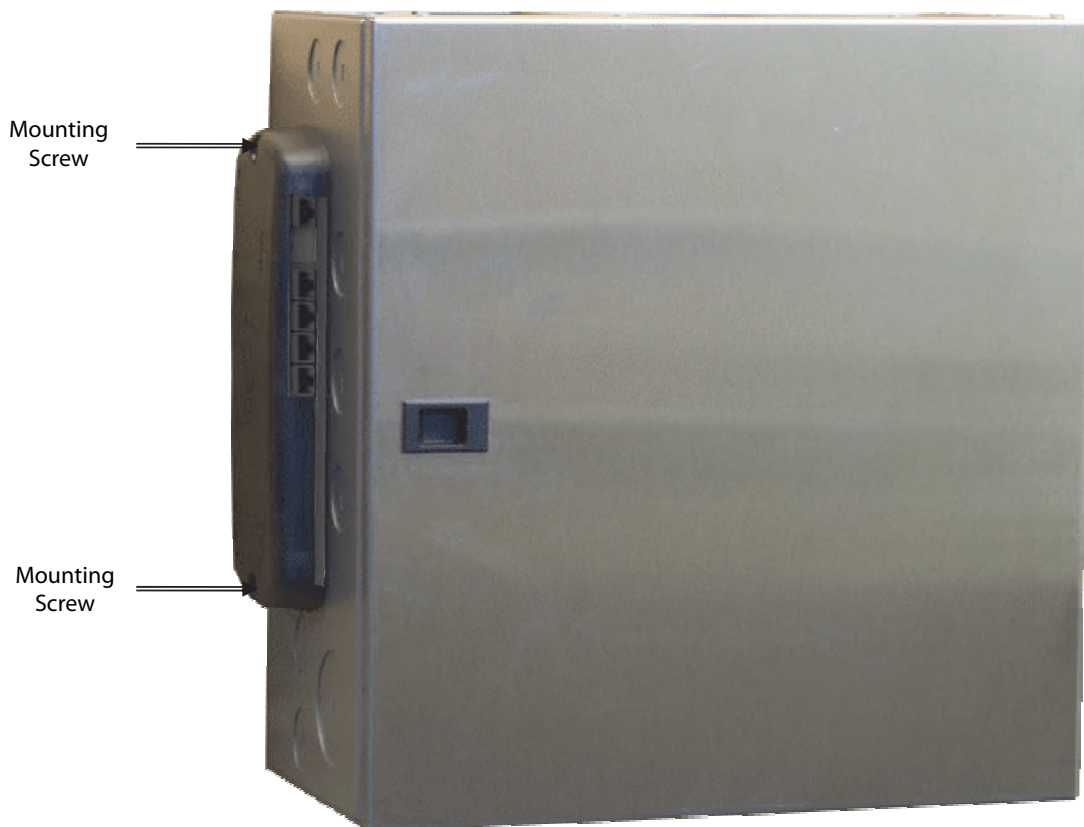


### Mounting the HUB Communications Manager

The GSLC provides mounting holes to support a HUB Communications Manager.

**To mount the HUB Communications Manager to the side of the GSLC enclosure:**

1. Locate the mounting holes on the side of the GSLC enclosure as shown in Figure 8 on page 10.
2. Remove the knockouts and add bushings.
3. Align the HUB (vertically) over the mounting holes with the HUB's ports facing forward.
4. Insert the mounting screws from the outside into the GSLC enclosure. The mounting screws are provided with the HUB.
5. Tighten until secure, but do not over-tighten.
6. Install CAT5 cabling as needed.
7. Install the protective shield for the HUB.



**Figure 22** Mounting the HUB to the GSLC Enclosure



# Wiring

**Table 2 Terminal Bus Bar (TBB) Wire Size and Torque Requirements**

Conductor Size		Torque Requirements	
AWG	mm <sup>2</sup>	In-lb	Nm
#14 – #10	2.5 – 4	20	2.3
#8	6 – 10	25	2.8
#6 – #3	16 – 25	35	4.0
#2	35	40	4.5
#1 – 1/0	50	50	5.7

## Grounding



**WARNING: Shock Hazard**

The unit must be connected to a grounded, permanent wiring system. If a bond is made between neutral and ground, make sure only one bond is present in the AC system at any time. **The GSLC comes equipped with a neutral-ground bond.** This bond may need to be disconnected. Some codes require the bond to be made at the main panel only.



**WARNING: Shock Hazard**

For all installations, the negative (–) battery conductor should be bonded to the grounding system at only one point. **The GSLC comes equipped with a negative-ground bond.** This bond may need to be disconnected. If the OutBack GFDI is present, it can provide the bond. See page 24.



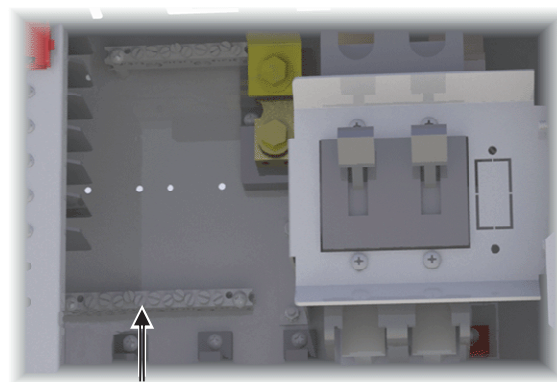
**IMPORTANT:**

Most OutBack products are not designed for use in a positive-grounded system. If it is necessary to build a positive-grounded system with OutBack products, contact OutBack Technical Support at +1.360.618.4363 before proceeding. Additionally, consult the online forum at [www.outbackpower.com/forum/](http://www.outbackpower.com/forum/), where this subject has been discussed extensively.

The GSLC's grounding TBB, which is bonded to the GSLC chassis, is located to the lower left of the main inverter disconnect. It accepts conductor sizes from 1/0 to #14 AWG (50 mm down to 2.5 mm).

This TBB accepts ground connections from the Radian inverter, FLEXmax charge controllers, the OutBack GFDI, the Grounding Electrode Conductor (GEC) or external earth ground, and other equipment.

See the *Radian Series Inverter/Charger Installation Manual* for recommendations on ground conductor sizing. Once the size is determined, see Table 2 for required torque values.



**Ground TBB**

**Figure 23 Grounding**

## Bonding

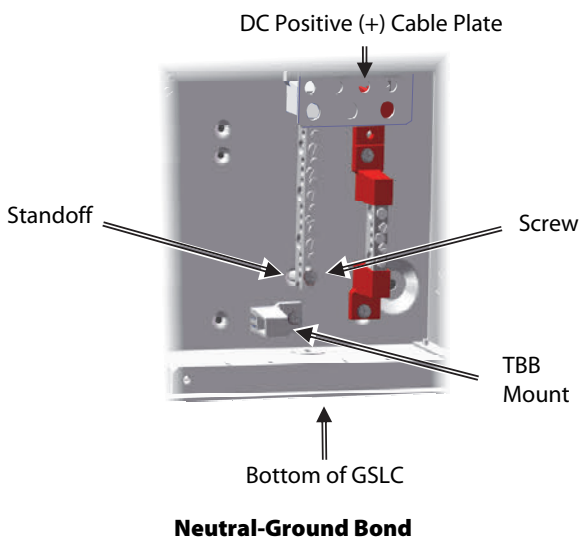
All GSLC models are equipped with a mechanical bond between AC neutral and ground. All models that do not include the GFDI are also equipped with a mechanical bond between DC negative and ground. These can be useful in stand-alone systems where no other bond is provided. If other bonds are present, or if the GFDI is installed later, the GSLC bonds need to be removed.



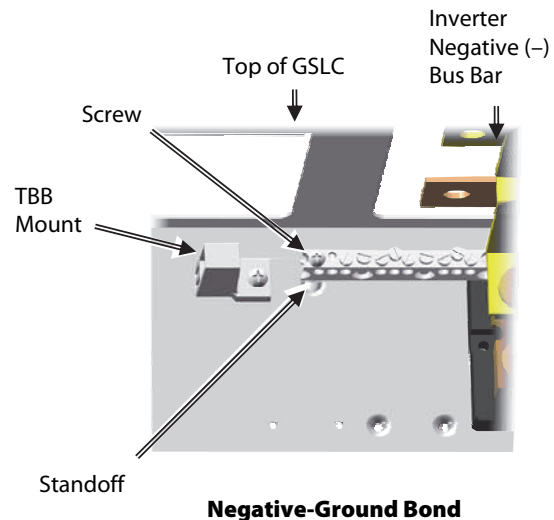
### WARNING: Shock Hazard

GSLC models purchased with the OutBack GFDI do not have a bond between negative and ground. If the GFDI is manually installed (see page 18 and the GFDI manual), the bond between must be removed. This must also be done if any other PV ground-fault device is present that establishes its own negative-ground bond.

The GSLC's **neutral bus bar** is located in the lower right portion of the GSLC. The neutral-ground bond is established at one end of the bar, near the base of the GSLC.



The GSLC's **negative (-) bus bar** is located near the top of the GSLC. It is attached to the inverter negative (-) bus and its shunt.



### To remove either of the bond connections:

1. Using a Phillips screwdriver, remove the screw shown above. Remove the star washer with it.
2. Remove the metal standoff beneath the bus bar. The screw and bus bar provide the mechanical bond to the chassis ground.
3. Rotate the TBB mount. Insert the bus bar into the open end of the TBB mount so that the TBB mount supports the bus bar. It may be necessary to loosen the TBB mount screw before rotating it.
4. Retighten the screw and star washer to secure the TBB mount.

### NOTES:

- If the TBB is connected directly to the enclosure by a screw, then the bond is connected.  
If the TBB is held by the TBB mount and the TBB mount is secured to the enclosure, the bond is disconnected.
- The installed Neutral TBB has white insulators. A second Neutral TBB with blue insulators is included in the kit for locations where blue is standard.

**Figure 24 Removing Bonding Connections**

## DC Wiring



### WARNING: Shock Hazard

Ensure all circuit breakers or disconnect devices are turned off or disconnected before connecting any wires.

## Inverter Wiring

The DC disconnects are connected directly to the inverter using bus bars during the process of mounting. See page 20 for more information.

## Battery Wiring

The Radian inverter requires two positive (+) and two negative (–) cables for proper installation. Consult the *Radian Series Inverter/Charger Installation Manual* for cable sizing and length recommendations appropriate for the specific installation. (The GSLC bus connections may allow a single larger conductor to be brought in from the battery, if sized correctly.)

The battery positive (+) cables connect to the DC positive (+) wiring plate. This plate is located directly beneath the main inverter disconnects. It is intended for several ring lugs to be bolted to it.

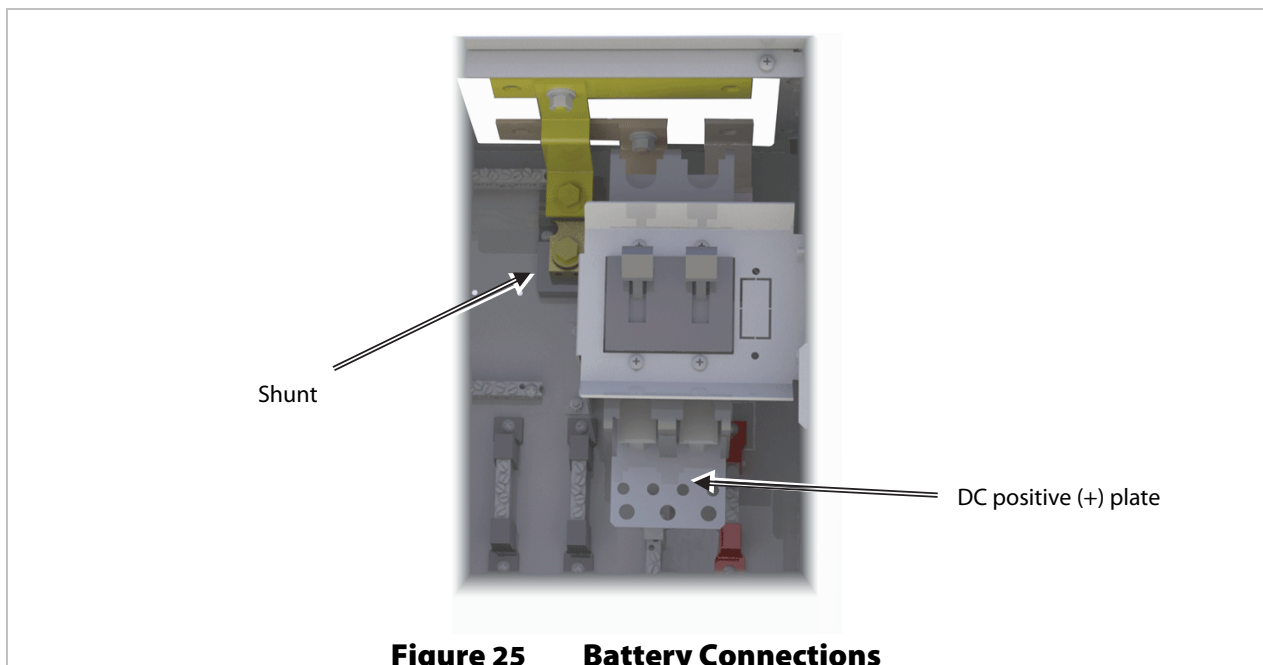
- The smaller holes have a diameter of 0.31" (8 mm).
- The larger have a diameter of 0.4" (10 mm).

The battery negative (–) cables connect to the pre-installed shunt. This shunt is located to the upper left of the main inverter disconnect. It is designed for several ring lugs to be bolted to it, with openings of 3/8" (10 mm) diameter.

See Table 1 on page 13 for required torque values.

Ensure DC disconnects are turned to the OFF position and **all** DC sources are disconnected (unbolt the battery end of the wires) before proceeding.

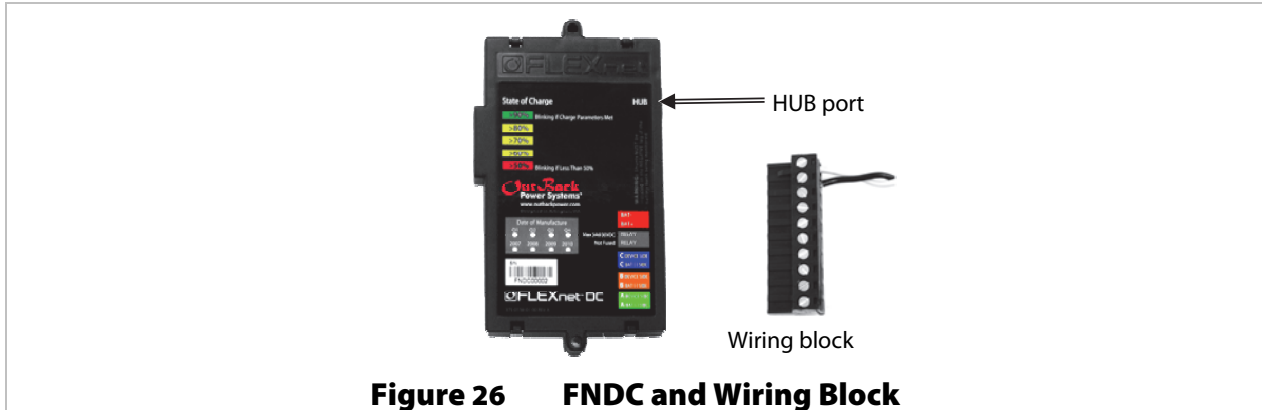
See the inverter's installation manual for additional information on battery wiring.



**Figure 25 Battery Connections**

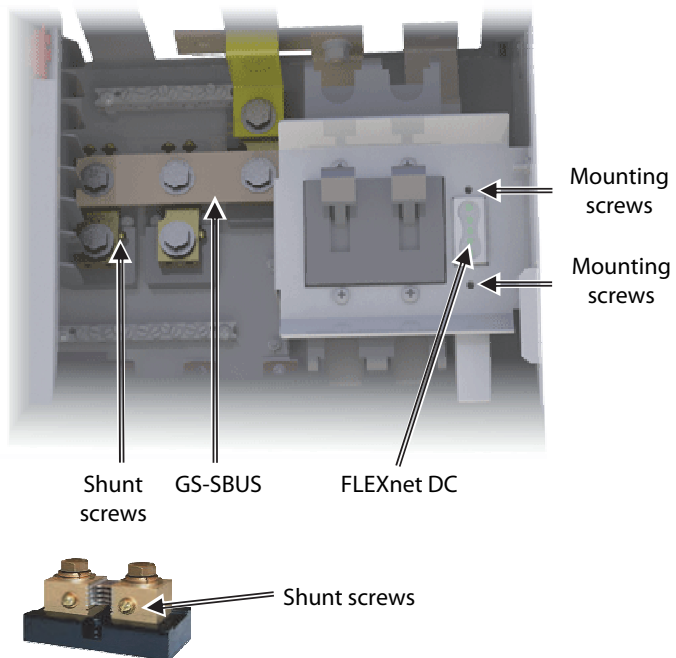
## Installing the FLEXnet DC

The OutBack FLEXnet DC (FNDC), or a similar battery monitor, may be added to the GSLC for observing DC current flow and providing battery state-of-charge information.



### To install the FNDC :

1. Assemble the FNDC wiring as shown in the manual for the FNDC.
  - Attach sense wires to FNDC wiring block and plug it into the FNDC.
  - Plug the CAT5 cable into the port labeled HUB.
2. Connect FNDC wiring to the GSLC.
  - The positive (+) and negative (-) battery voltage sense conductors should connect directly to the battery bank.
  - The shunt sensing wires should connect to the screws on each shunt. It may be necessary to remove the GS-SBUS to reach the screws.
3. Mount the FNDC by inserting it into the opening to the right of the inverter disconnects. It may be necessary to hold it in place.
4. Secure the FNDC with mounting screws above and below. Tighten until secure, but do not over-tighten.



When connecting sensing wires: The end of the shunt connected to the GS-SBUS is the negative (-) battery connection and should be wired accordingly. The other end of the shunt is the “device” or “load” end and should be wired accordingly.

See the FLEXnet DC manual for more information on these connections. See Figure 42 on page 40 for an example of typical system wiring.

## DC Devices

In addition to inverter or PV connections, other devices may be connected to the GSLC, such as DC loads or sources. The wiring on these devices will vary with the application. In most cases the device will have a separate circuit breaker which is mounted on the rail as shown on page 18. It will be wired into the battery system using the existing bus bars or shunts. The number and location of these connections will vary with the options or accessories installed.

## PV and Charge Controller Wiring

When wiring the FLEXmax, FLEXmax Extreme, or another charge controller to the GSLC, a number of elements are involved. These elements include the PV or RE source, the battery connections, the disconnect circuit breaker, the PV ground-fault device, and the charge controller.

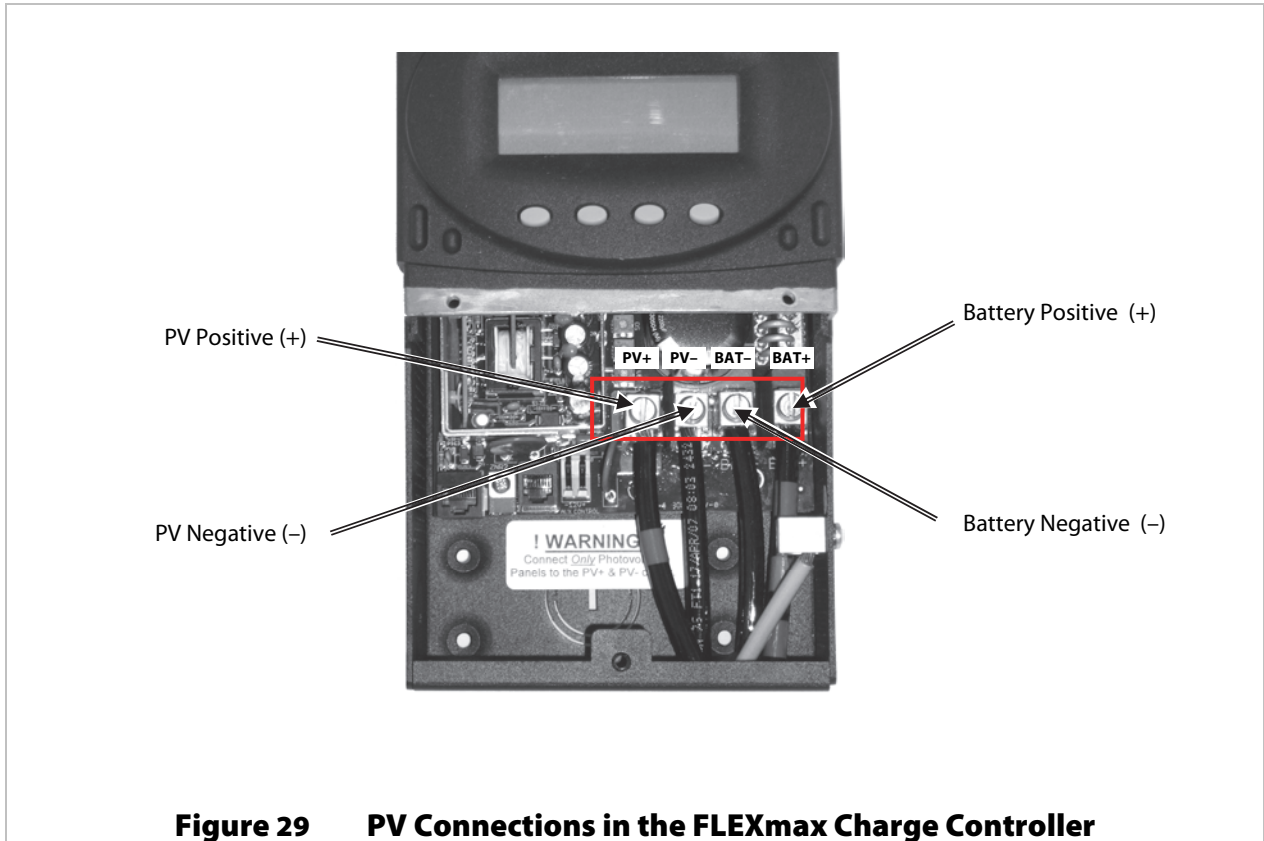
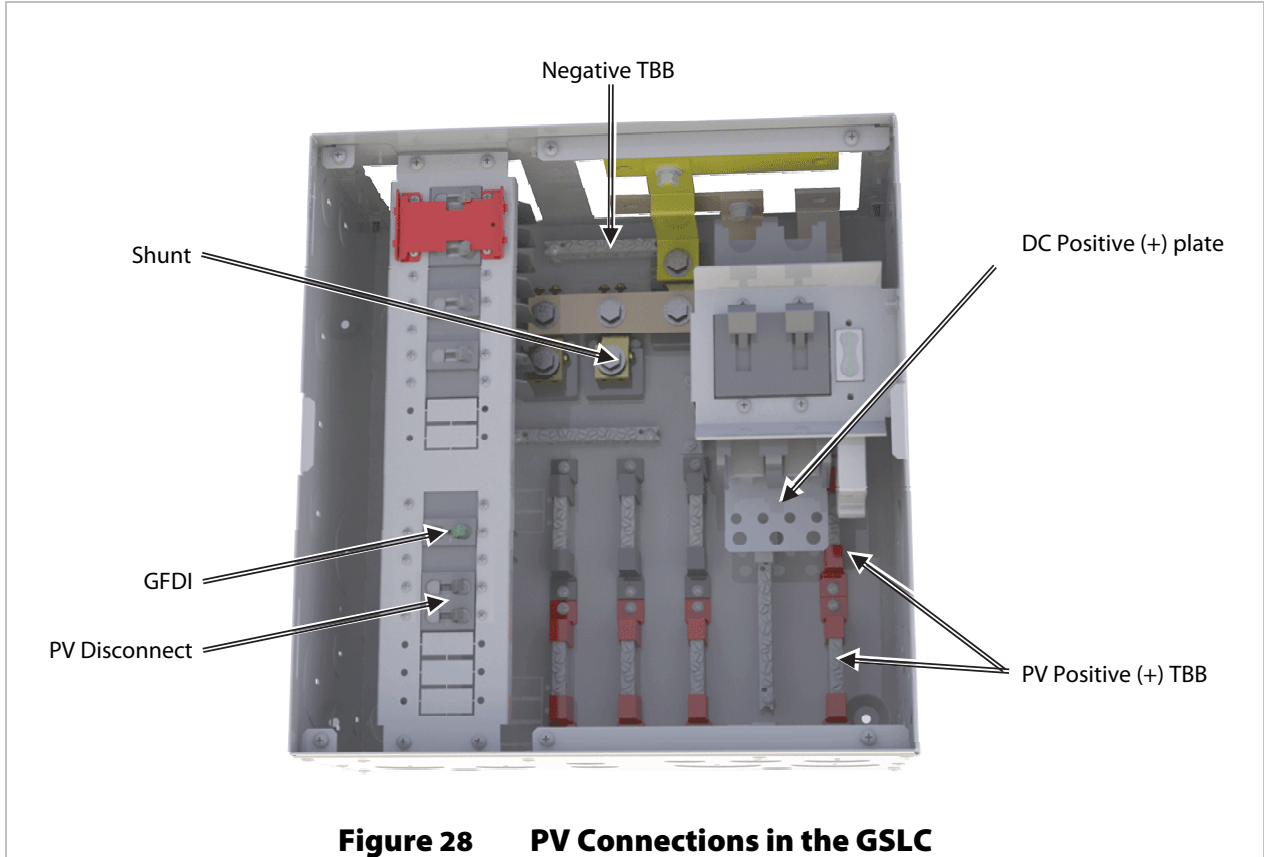
These instructions are written for a PV source which uses the OutBack FLEXmax (or FLEXmax Extreme) charge controller and the GFDI. Other applications will be similar.

### To make PV and charge controller connections:

1. Connect the PV positive wire to the GSLC's PV positive (+) TBB (see Figure 28).
2. Connect the PV negative wire to the charge controller's PV negative (-) terminal (see Figure 29).
3. Install a wire from the PV TBB to the PV disconnect circuit breaker (see Figure 28).
4. Install a wire from the PV disconnect to the charge controller's PV positive (+) terminal.
5. Install a wire from the GSLC's DC positive (+) cable plate to one pole of the GFDI.
6. Install a wire from the GFDI to the charge controller's positive (+) battery terminal.
7. Install a wire from the charge controller's negative (-) battery terminal to the GSLC's negative TBB. If the FLEXnet DC or another battery monitor is in use, this wire should connect to the shunt which monitors that charge controller.
8. Repeat all steps for a second charge controller, if necessary.

### NOTES:

- Each TBB accepts conductors from 1/0 AWG (70 mm<sup>2</sup>) to #14 AWG (2.5 mm<sup>2</sup>) in size. See Table 2 on page 23 for required torque values.
- For other GSLC required torque values (such as shunts and circuit breakers), see Table 1 on page 13.
- For torque values, wire sizes, and other information concerning the FLEXmax charge controller, see the *FLEXmax Series Charge Controllers Owner's Manual*.
- For more information on specific wiring of the GFDI, see the GFDI manual.
- A diagram that shows typical wiring for a PV system, including the FLEXnet DC, GFDI, and other elements of the system, is shown on page 40.
- A fully-assembled GSLC diagram with the elements mentioned above (as well as the AC system) is shown on page 40.



## AC Wiring



### WARNING: Shock Hazard

Ensure all circuit breakers or disconnect devices are turned off or disconnected before wiring. Make certain the inverter and other active devices are turned off or disabled before wiring.

## Split-Phase Wiring

The GSLC can have multiple terminal bus bars for multiple AC connections. Because the Radian inverter possesses two sets of AC input connections and one set of output connections, up to three TBB sets are available. Each set of bus bars are paired in red and black, for the 120/240 Vac connections required by the Radian inverter.

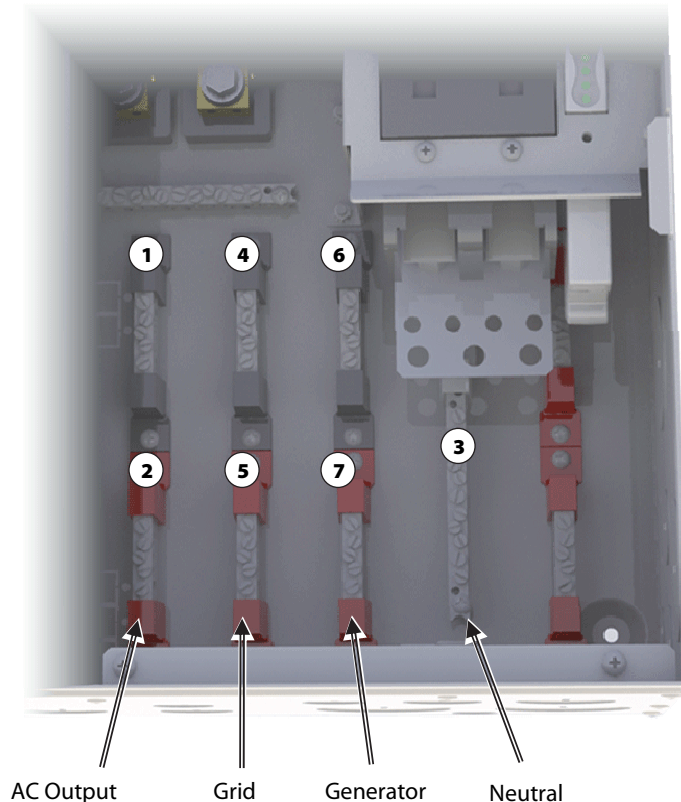
The TBB set on the left is generally used for the inverter's AC output connections. The central TBB set is for utility grid connections and the right TBB set is for a generator. The preassembled GSLC models follow this convention.

Each TBB accepts conductors from 1/0 (70 mm<sup>2</sup>) to #14 AWG (2.5 mm<sup>2</sup>). See Table 2 on page 23 for required torque values.

If steps are inappropriate for a given system (such as instructions for a generator when none is present), they can be ignored.

### To make the external AC connections to the split-phase GSLC:

1. Connect the L1 wire from the AC load panel to black TBB **1** (AC OUT - HOT LEG 1). Connect the L2 wire from the AC load panel to red TBB **2** (AC OUT - HOT LEG 2).
2. Connect the neutral wire from the AC load panel to neutral TBB **3**.
3. Connect the L1 wire from the utility grid panel (if present) to black TBB **4** (GRID IN - HOT LEG 1). Connect the L2 wire from the utility grid panel to red TBB **5** (GRID IN - HOT LEG 2).
4. Connect the neutral wire from the utility grid panel (if present) to neutral TBB **3**.
5. Connect the L1 wire from the generator (if present) to black TBB **6** (GEN IN - HOT LEG 1). Connect the L2 wire from the generator to red TBB **7** (GEN IN - HOT LEG 2).
6. Connect the neutral wire from the generator (if present) to neutral TBB **3**.



**Figure 30 AC Terminal Bus Bars (split-phase)**

# Installation

## Bypass Assembly

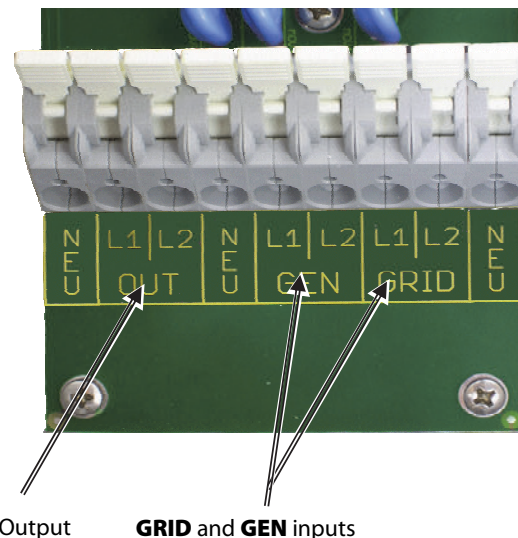
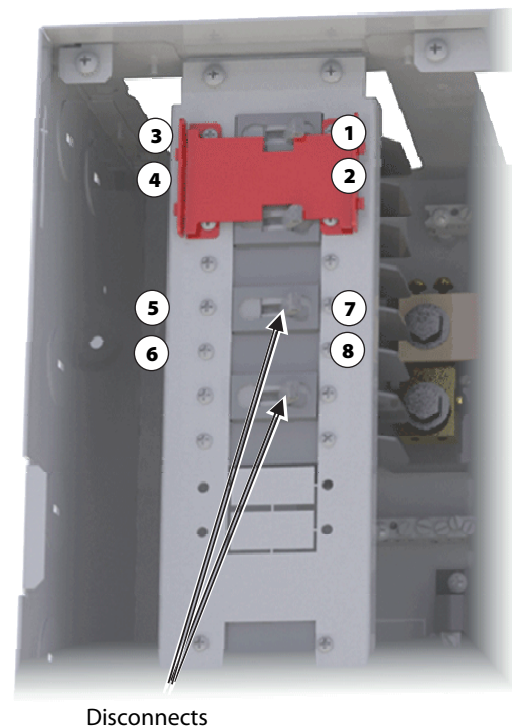
Bypass switching can be used when the inverter is shut down for maintenance. This topic is discussed more beginning on page 34. The GSLC can be equipped with the GS-IOB-120/240VAC bypass assembly. The instructions on this page are for making external connections to the bypass assembly after installation. (The installation wiring for the GS-IOB-120/240VAC is described on page 33.)

If the GSLC has no bypass assembly, wiring connections should be made directly to each TBB from the Radian inverter, AC sources, and loads. These connections are designated in Figure 30.

Wiring diagrams for an assembled 120/240 Vac system are shown beginning on page 37.

### To make the connections to the Radian inverter:

1. Designate the top AC circuit breaker as the inverter AC output disconnect. Install a wire from the black AC output TBB (as shown in Figure 30) to the disconnect marked by ①.
2. Install a wire from the red AC output TBB to the disconnect marked by ②.
3. Install wires on the left side of the disconnect as marked by ③ and ④. Connect these wires to the appropriate L1 and L2 output terminals on the Radian inverter.
4. Designate the third AC circuit breaker from the top as the disconnect for one AC source (**GRID** or **GEN**). Install a wire from the black source circuit TBB (as shown in Figure 30) to the disconnect marked by ⑤.
5. Install a wire from the red source circuit TBB to the disconnect marked by ⑥.
6. Install wires on the right side of the disconnect as marked by ⑦ and ⑧. Connect these wires to the appropriate L1 and L2 input terminals on the Radian inverter (the terminals labeled either **GRID** or **GEN**).
7. If a second AC source is present, repeat these steps using the second circuit breaker.
8. Install a wire on the inverter's **NEU** terminal and connect it to the GSLC's neutral TBB (as shown in Figure 30). *Only one neutral connection is required.*



**Figure 31 Inverter AC Connections (split-phase)**



## Single-Phase Wiring

The GSLC allows multiple terminal bus bars (TBB) for multiple AC connections. Because the Radian inverter possesses two sets of AC input connections and one set of output connections, three terminal bus bars are available for hot connections, as well as one neutral bus bar. The hot bus bars have brown insulators in 230 Vac models. A blue bus bar for neutral connections is also available.

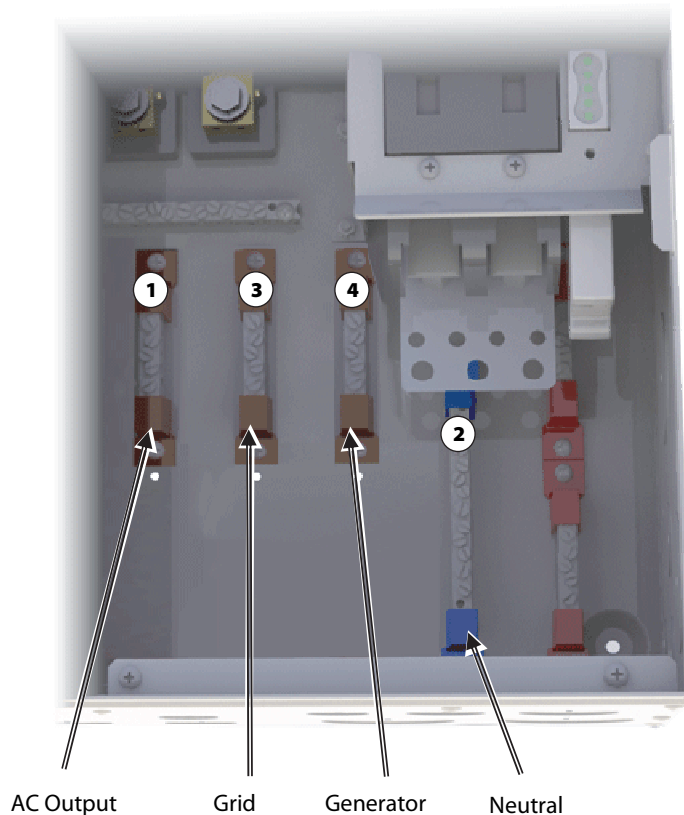
The TBB on the left is generally used for the inverter's AC output connections. The central TBB is for utility grid connections and the right TBB is for a generator. The preassembled GSLC models follow this convention.

Each TBB accepts conductors from 70 mm<sup>2</sup> (1/0 AWG) to 2.5 mm<sup>2</sup> (#14 AWG). See Table 2 on page 23 for required torque values.

If steps are inappropriate for a given system (such as instructions for a generator when none is present), they can be ignored.

### To make external AC connections to the single-phase GSLC:

1. Connect the hot wire from the AC load panel to brown TBB **1** (AC Output).
2. Connect the neutral wire from the AC load panel to neutral TBB **2**.
3. Connect the hot wire from the utility grid panel (if present) to brown TBB **3** (Grid).
4. Connect the neutral wire from the utility grid panel (if present) to neutral TBB **2**.
5. Connect the hot wire from the generator (if present) to brown TBB **4** (Generator).
6. Connect the neutral wire from the generator (if present) to neutral TBB **2**.



**Figure 32 AC Terminal Bus Bars (single-phase)**

## Bypass Assembly

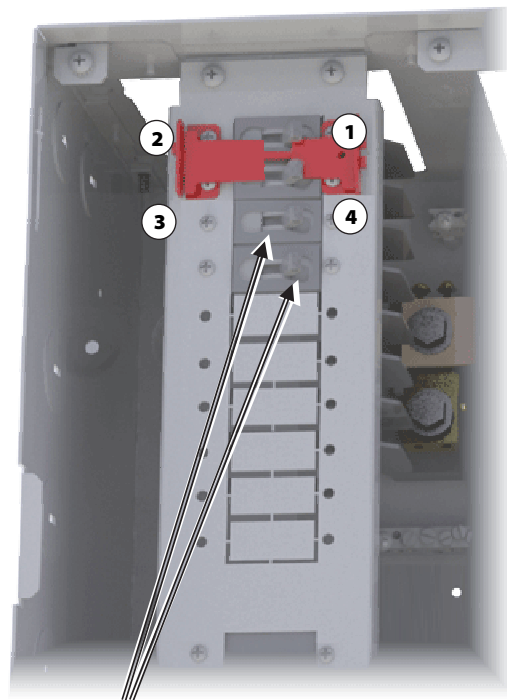
Bypass switching can be used when the inverter is shut down for maintenance. This topic is discussed more beginning on page 34. The GSLC can be equipped with the GS-IOB-230VAC bypass assembly. The instructions on this page are for making external connections to the bypass assembly after installation. (The installation wiring for the GS-IOB-230VAC is described on on page 34.)

If the GSLC has no bypass assembly, wiring connections should be made directly to each TBB from the Radian inverter, AC sources, and loads. These connections are designated in Figure 32.

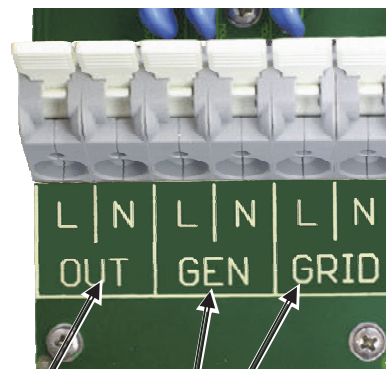
Wiring diagrams for an assembled 230 Vac system are shown beginning on page 39.

### To make the connections to the Radian inverter:

1. Designate the topmost AC circuit breaker as the inverter AC output disconnect. Install a wire from the AC output circuit TBB (as shown in Figure 32) to that disconnect as marked by **1**.
2. Install a wire on the left side of the disconnect as marked by **2**. Connect the wire to the appropriate output terminals on the Radian inverter.
3. Designate the third AC circuit breaker as the disconnect for one AC source (**GRID** or **GEN**). Install a wire from the TBB of the appropriate source circuit (as shown in Figure 32) to the left side of that disconnect as marked by **3**.
6. Install a wire on the right side of the source disconnect as marked by **4**. Connect the wire to the appropriate input terminal on the Radian inverter (the terminal labeled either **GRID** or **GEN**).
7. If a second AC source is present, repeat these steps using the fourth circuit breaker.
8. Install a wire on the inverter's **NEU** terminal and connect it to the GSLC's neutral TBB (as shown in Figure 32). *Only one neutral connection is required.*



Disconnects



AC Output

**GRID** and **GEN** inputs

**Figure 33 Inverter AC Connections (single-phase)**

## Wiring the AC Bypass Assembly

The GSLC175-120/240, GSLC175-PV-120/240, GSLC175-230, and GSLC175-PV-230 each come equipped with a maintenance bypass assembly. Alternately, they can be equipped with a bypass assembly using the GS-IOB-120/240VAC or GS-IOB-230VAC accessory kit as appropriate. The accessory kit should be installed according to its own instructions. Once installed, it can be wired by following the steps shown in Figure 34 or Figure 35.

The operation of the bypass assembly is discussed on page 34. A series of GSLC diagrams with the bypass wiring (as well as the rest of both the AC and DC systems) are shown beginning on page 39. These drawings show the utility grid circuit connected to the bypass assembly.

**NOTE:** Only one AC source may be bypassed with this assembly, even if two sources are present. Bypassing multiple AC sources will usually connect the sources to each other.

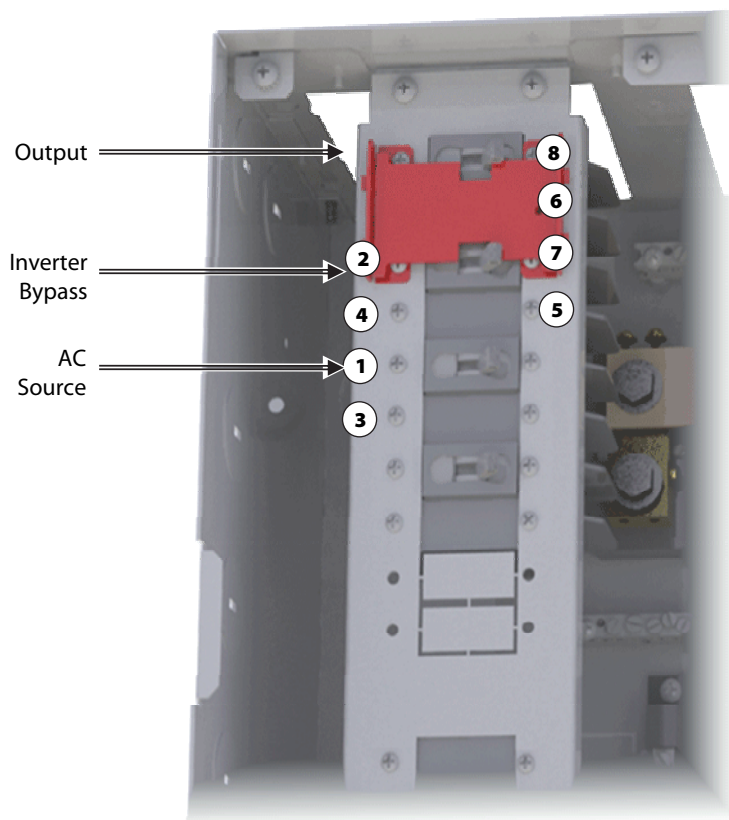


### WARNING: Shock Hazard or Equipment Damage

- If multiple inverters are in use, see page 34 before attempting to install or use the bypass assembly.
- Bypassing multiple sources will usually connect the sources to each other, which may damage one or both sources. It can otherwise result in power being routed to inappropriate places.

#### To wire the GS-IOB-120/240VAC after installation:

1. On the disconnect for the AC source that will be used during bypass, install a wire from the **upper** pole as shown by (1). Connect it to the **upper** pole of the inverter bypass switch as shown by (2).
2. From the same disconnect, install a wire on the **lower** pole as shown by (3). Connect it to the **lower** pole of the inverter bypass switch as shown by (4).
3. On the right side of the inverter bypass switch, install a wire on the lower pole as shown by (5). Connect it to the right side of the **lower** pole on the output switch (6). Install a second wire between the **upper** poles of each switch as shown by (7) and (8).

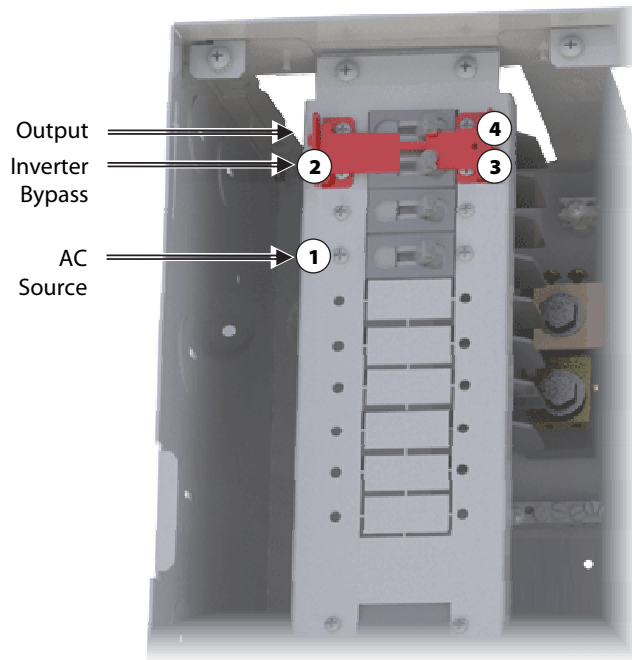


**Figure 34 Maintenance Bypass Wiring (split-phase)**

## Installation

### To wire the GS-IOB-230VAC after installation:

1. On the disconnect for the AC source that will be used during bypass, install a wire from the left side as shown by (1). Connect it to the input bypass switch as shown by (2).
2. Install a wire on the right side of the input bypass switch as shown by (3). Connect it to the right side of the output switch as shown by (4).



**Figure 35 Maintenance Bypass Wiring (single-phase)**

## Multiple-Inverter Installations (Stacking Inverters)

When multiple Radian inverters are stacked for additional power, the basic wiring is repeated for each inverter. However, several factors need to be considered.

- One GSLC is required for each Radian inverter. A single GSLC cannot be sized to handle the requisite current for multiple Radian inverters.
- If more than two Radian inverters are installed, it is recommended to install a separate distribution panel to distribute incoming power to each GSLC individually. It may be advisable to install separate AC distribution panels to distribute input and output power to each GSLC.
- The GSLC maintenance bypass assemblies cannot be used when more than one Radian inverter is stacked. See the next section.

## Bypass Switches

Inverter systems are often equipped with maintenance bypass switches or interlocks. If the inverter system ever needs to be shut down or removed, its AC sources and loads must be disconnected. A bypass device allows the AC source to “bypass” the inverter and deliver power directly to the loads. This can minimize disruption to the system and it avoids the need for extensive rewiring.

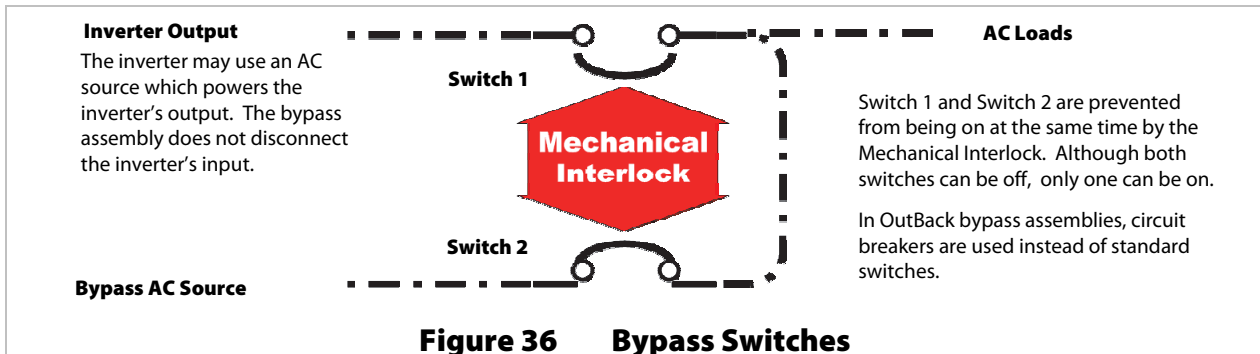


### **WARNING: Shock Hazard or Equipment Damage**

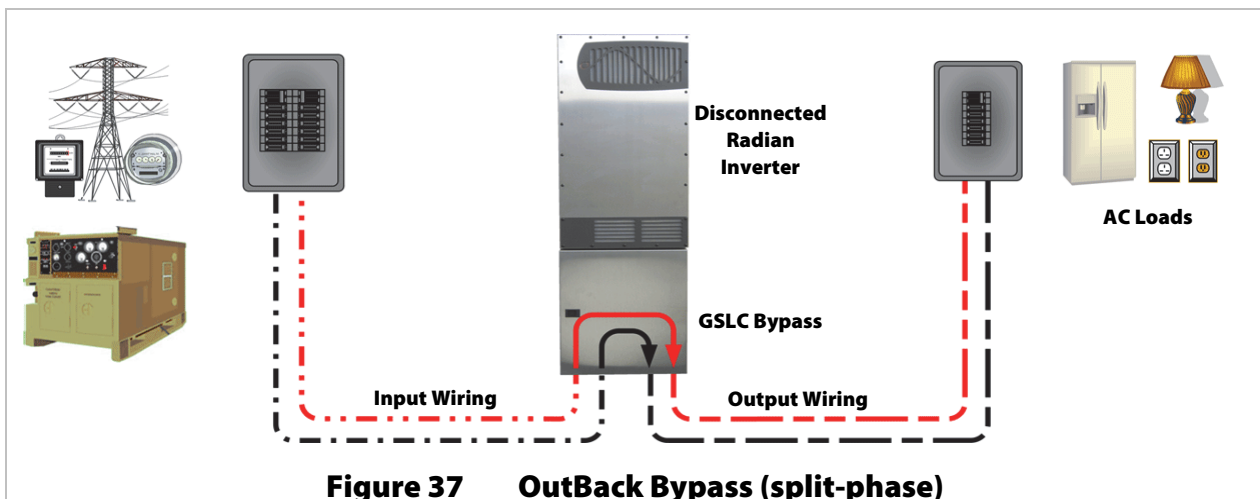
- Bypassing multiple sources will usually connect the sources to each other, which may damage one or both sources. It can otherwise result in power being routed to inappropriate places.
- The bypass assembly does not disconnect the inverter’s AC input. Even with the inverter bypassed, any AC input source may be a shock hazard unless disconnected.

In Figure 36, when Switch 1 is on (normal operation), the inverter's output sends power to the loads. Switch 2 is off, preventing the inverter from sending power back to the AC source (backfeeding).

When Switch 2 is on (bypass operation), the AC source sends power directly to the loads. Switch 1 is off, removing the inverter's output from the loads. This also prevents the AC source from backfeeding the inverter. With the inverter removed from the circuit, maintenance can be performed as necessary.



The GSLC can be ordered with bypass circuit breakers for this purpose, or it has a bypass option (the GS-IOB-120/240VAC or GS-IOB-230VAC) which can be installed.



### IMPORTANT:

If multiple Radian inverters are stacked in a single system, then these devices cannot be used. The bypass function must be simultaneous for all inverters. The GSLC bypass kits operate independently, not simultaneously.

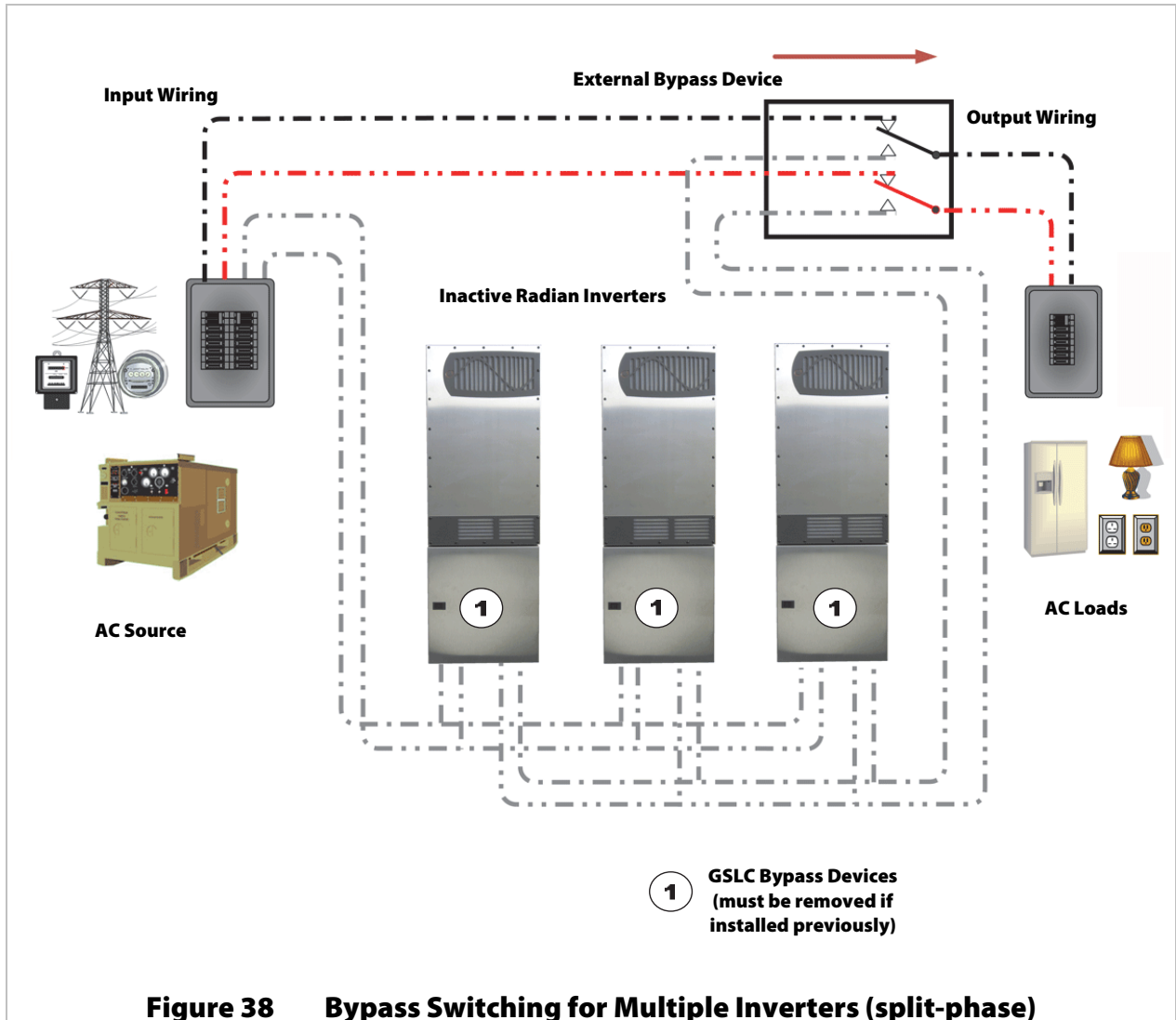
Both manual and automatic double-pole, double-throw bypass switches are commonly available in a range of sizes and options. These are highly recommended for systems larger than a single inverter. In a new system with multiple Radian inverters, the basic GSLC should be used in conjunction with an external assembly of this kind, as shown in Figure 38. The GS-IOB kits should not be installed, or if previously installed, should be removed and all wires disconnected.



### WARNING: Shock Hazard or Equipment Damage

Using independent bypass devices on multiple inverters can result in power being routed to inappropriate places. This could lead to an electric shock or to equipment damage.

# Installation



**Figure 38 Bypass Switching for Multiple Inverters (split-phase)**

# Wiring Diagrams

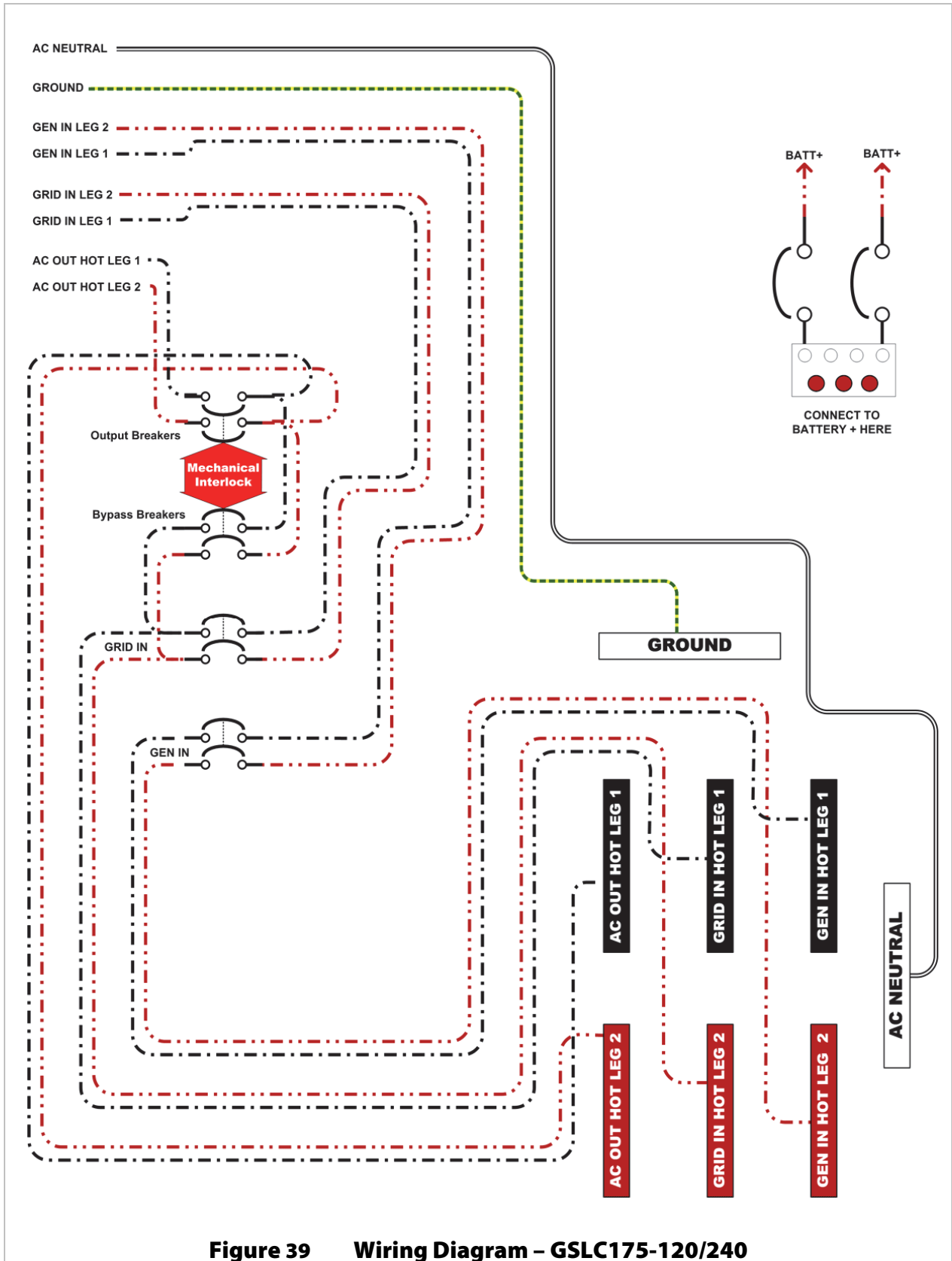
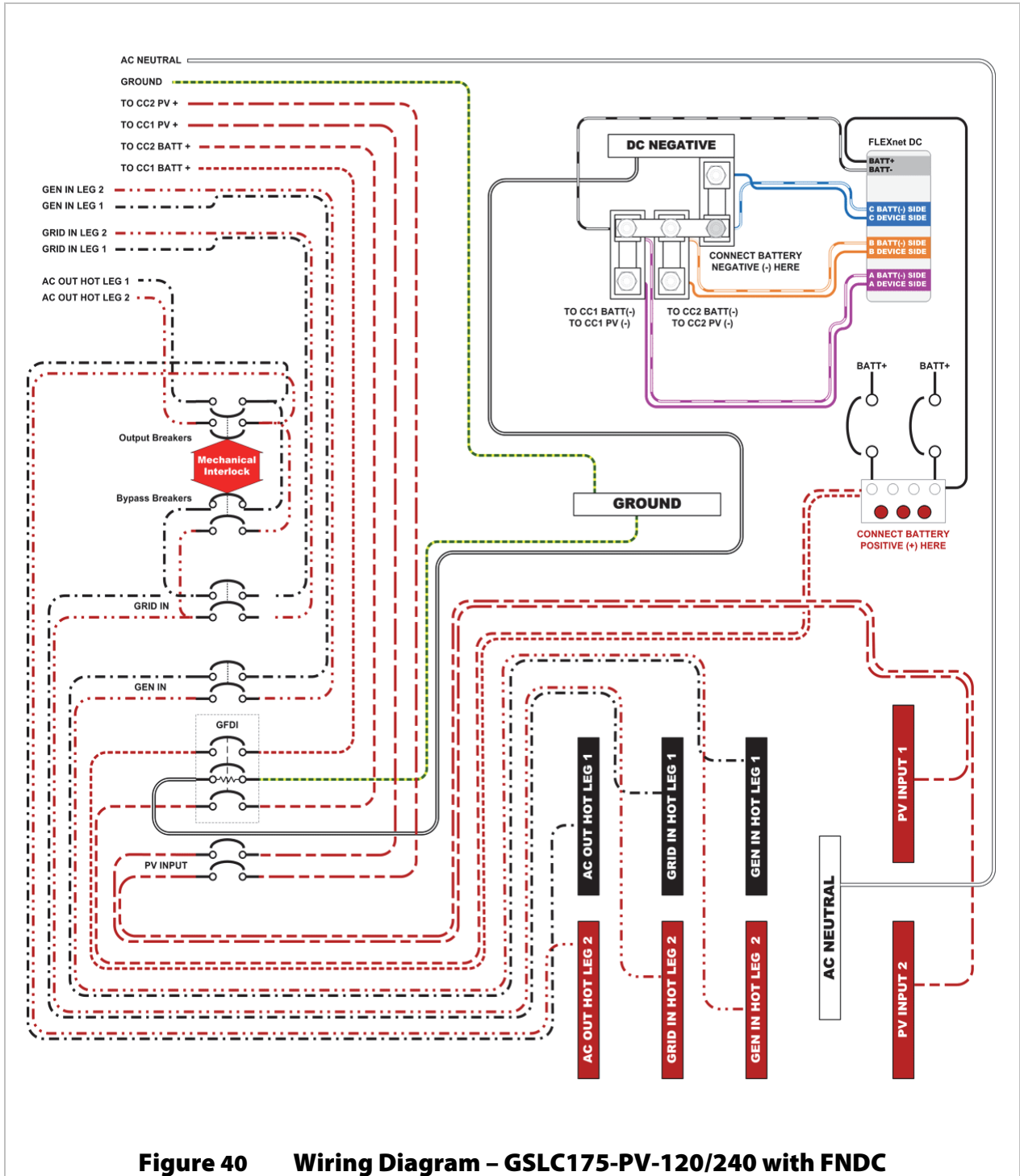


Figure 39 Wiring Diagram – GSLC175-120/240



**Figure 40** Wiring Diagram – GSLC175-PV-120/240 with FNDC



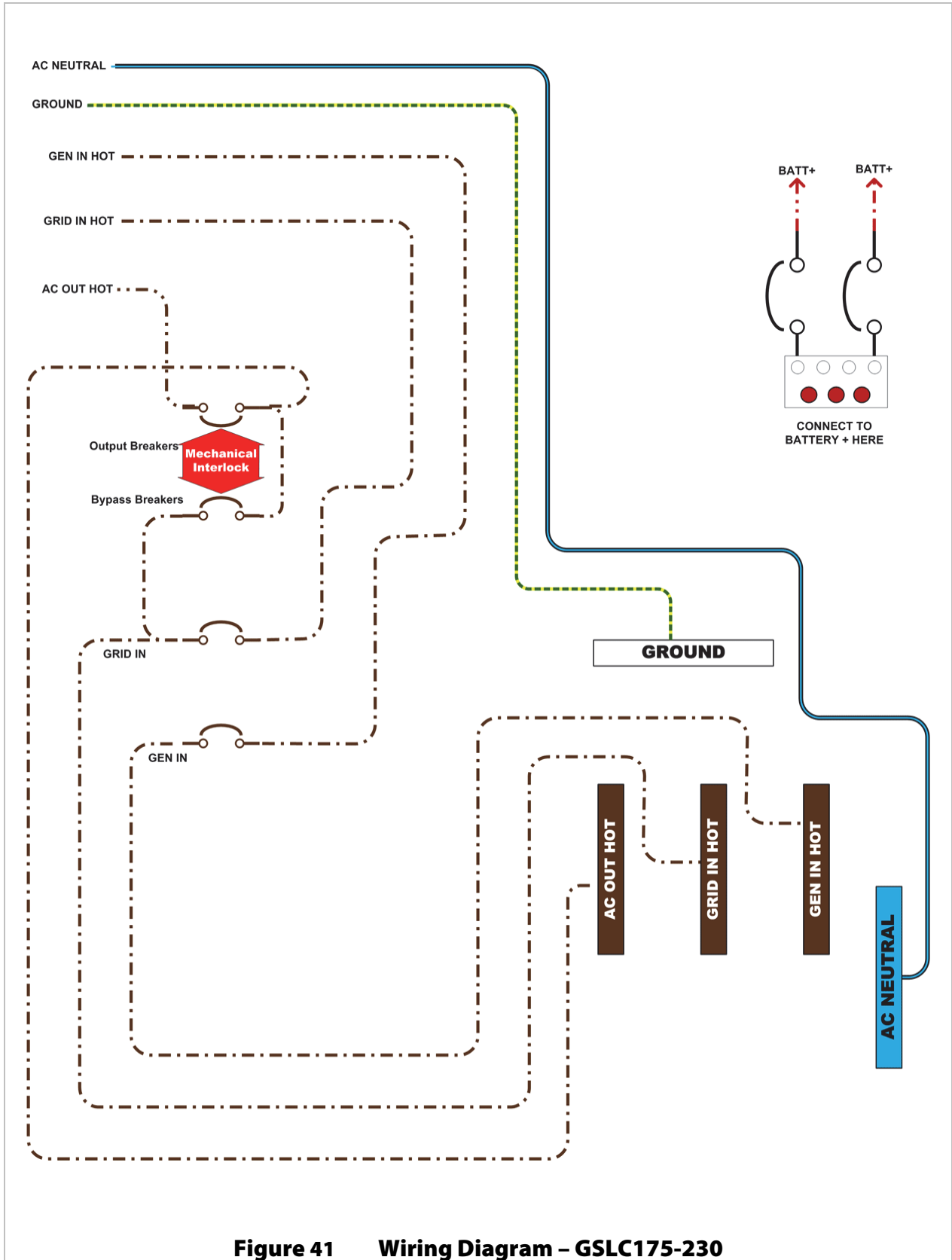
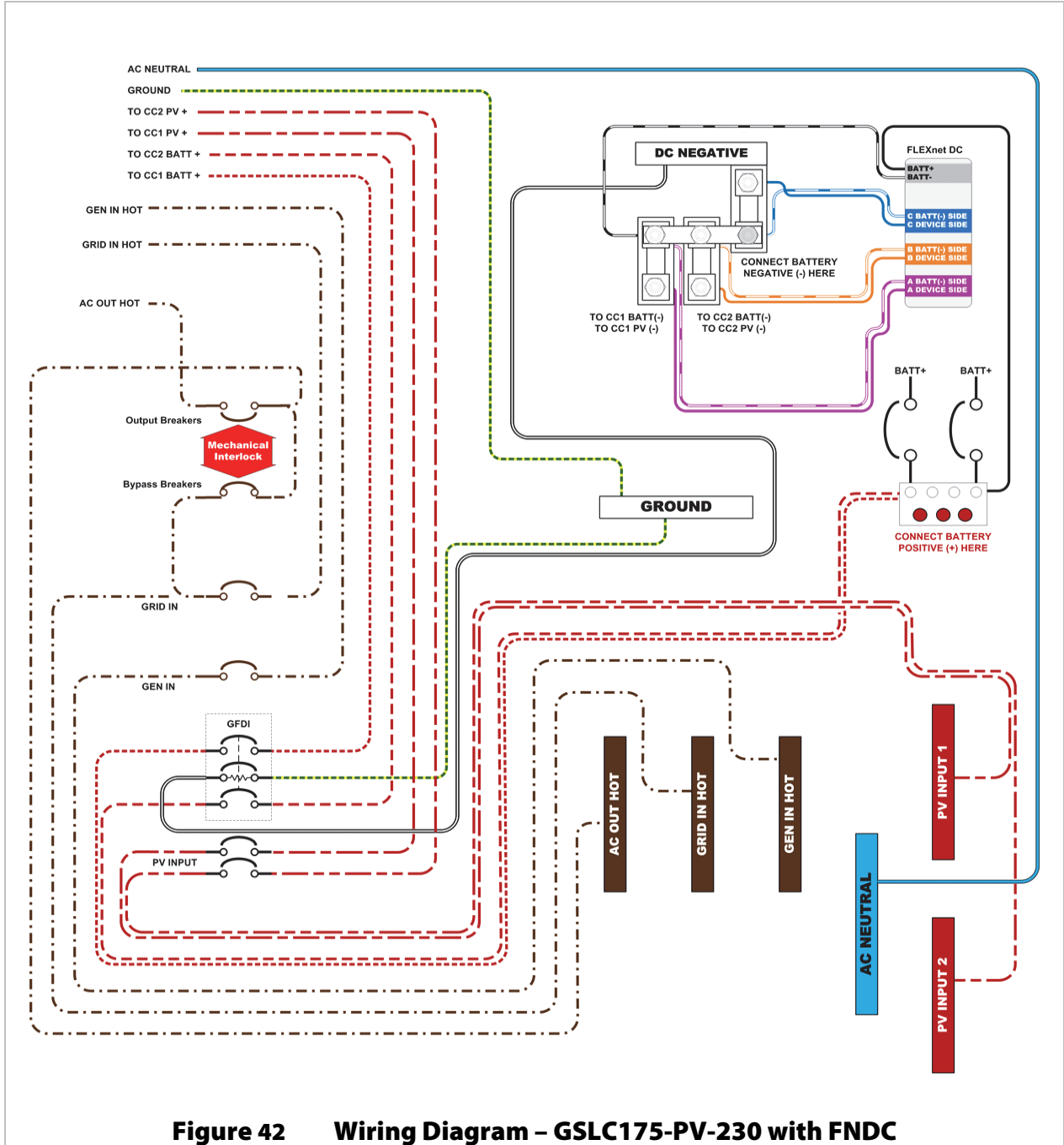


Figure 41 Wiring Diagram – GSLC175-230

# Installation



**Figure 42** Wiring Diagram – GSLC175-PV-230 with FNDC



# Specifications

## Electrical Specifications

**Table 3 Electrical Specifications**

<b>Specification</b>	<b>Measurement</b>
Maximum Input Voltage	600 Volts
Maximum Input Current	500 Amps
Operating Frequency Range	50/60 Hz to DC

## Mechanical Specifications

**Table 4 Mechanical Specifications**

<b>Specification</b>	<b>Measurement</b>
Dimensions (H x W x D)	17" x 16" x 8.5" (43.2 cm x 40.6 cm x 21.6 cm)
Shipping Dimensions (L x W x H)	23.25" x 20.5" x 13.25" (59.1 cm x 52.1 cm x 33.7 cm)
Weight	26 lb (11.8 kg) minimum — varies with options
Shipping Weight	34 lb (15.4 kg) minimum — varies with options
Enclosure Type	Indoor

## Regulatory Specifications

- UL 1741, 2<sup>nd</sup> Edition, Revised January 28, 2010, Static Inverter and Charge Controllers for Use in Photovoltaic Power Systems
- Canadian Electrical Code, Part I (CSA C22.2 No. 107.1-01 (R2006))

## Definitions

The following is a list of initials, terms, and definitions used in conjunction with this product.

**Table 5 Terms and Definitions**

<b>Term</b>	<b>Definition</b>
AC	Alternating Current; refers to voltage produced by the inverter, utility grid, or generator
AUX	One of several auxiliary outputs on the GS inverter/charger.
CSA	Canadian Standards Association; establishes Canadian national standards and the Canadian Electrical Code, including C22.1 and C22.2
DC	Direct Current; refers to voltage produced by the batteries or renewable source
DVM	Digital Voltmeter
FNDC	OutBack battery monitor; used to measure battery state of charge
GFDI	Ground Fault Detector Interrupter; a safety device for PV systems
PV	Photovoltaic
RE	Renewable Energy
UL	Underwriters Laboratories; refers to a set of safety standards governing electrical products



# Index

## **A**

AC Bypass Assembly .....	30, 32, 33, 34
AC Circuit Breakers .....	18
AC Terminal Bus Bars .....	29, 31
AC Wiring .....	29, 37, 39
120/240 Vac .....	29, 37
230 Vac .....	31, 39
Additional Components .....	11

## **B**

Bonding .....	24
Bypass Switches .....	34
Bypass Switching for Multiple Inverters .....	36

## **C**

Charge Controller .....	3, 21, 27
Circuit Breaker Size .....	13
Components	
Basic GSLC .....	4
GSLC175-120/240 .....	5
GSLC175-230 .....	6
GSLC175-PV-120/240 .....	7
GSLC175-PV-230 .....	8
Conduit Sizes .....	10
CSA .....	41

## **D**

DC Devices .....	27
DC Disconnects .....	16
DC Positive Cable Plate .....	13
Assembling .....	14
DC Shunts .....	17
DC Wiring .....	25
Definitions .....	42
Dimensions .....	9
DVM .....	42

## **E**

Environmental Requirements .....	9
----------------------------------	---

## **F**

FLEXmax Charge Controller .....	3, 21, 27
FLEXnet DC .....	26
Front Door .....	12

## **G**

GFDI .....	18
Grounding .....	23

## **H**

HUB Communications Manager .....	22
----------------------------------	----

## **I**

Interior Cover .....	13
Internal Hardware .....	13
Inverter Main Disconnects .....	16
Inverter Positive Bus Bars .....	15

## **K**

Knockouts .....	10
-----------------	----

## **M**

Materials Required .....	9
Mounting	
Charge Controller .....	21
GSLC .....	19
HUB .....	22
Inverter .....	19
Mounting Holes .....	10

## **N**

Negative-Ground Bonding .....	24
Neutral-Ground Bonding .....	24

## **O**

Optional Hardware .....	11
-------------------------	----

# Index

## **P**

Positive Bus Hardware .....	13, 14, 15
PV Circuit Breakers .....	18
PV Wiring .....	27

## **R**

Regulatory.....	41
-----------------	----

## **S**

Specifications	
Electrical.....	41
Mechanical .....	41
Regulatory.....	41
Stacking Inverters.....	34

## **T**

Tools Required.....	9
Top Cover .....	12

Torque Requirements .....	13
---------------------------	----

## **U**

UL.....	41
---------	----

## **W**

Wire Size and Torque Requirements.....	23
Wiring	
120/240 Vac .....	29, 37
230 Vac .....	31, 39
AC.....	29, 37, 39
Bonding.....	24
Charge Controller .....	27
DC.....	25
FLEXnet DC .....	26
Grounding.....	23
PV .....	27

**THIS PAGE INTENTIONALLY LEFT BLANK.**



Corporate Headquarters  
5917 – 195<sup>th</sup> St NE  
Arlington, WA 98223 USA  
+1.360.435.6030

European Office  
Hansastraße 8  
D-91126  
Schwabach, Germany  
+49.9122.79889.0